

# DEWALT®

# ONSITE

NOVITÀ E PROMOZIONI

FEBBRAIO - AGOSTO 2023

THE  
NEXT DIMENSION  
IN POWER™

NEW  
5AH

[www.DEWALT.com](http://www.DEWALT.com)

GUARANTEED TOUGH®

# NUOVA TRONCATRICE RADIALE 305MM BRUSHLESS 54V



TECNOLOGIA  
FRENATA RIGENERATIVA



DOPPIA INCLINAZIONE DX/SX



BASE IN ALLUMINIO  
RETTIFICATA

ROTAZIONE DELLA TAVOLA  
CON PUNTI PREFISSATI  
E SCALA GRADUATA  
IN ACCIAIO INCISA

BATTERIA SINGOLA



PARTENZA LENTA

PESO (solo  
corpo macchina)  
23.2KG

PROLUNGHE DEL PIANO  
DI LAVORO CON PRESA  
PER IL TRASPORTO

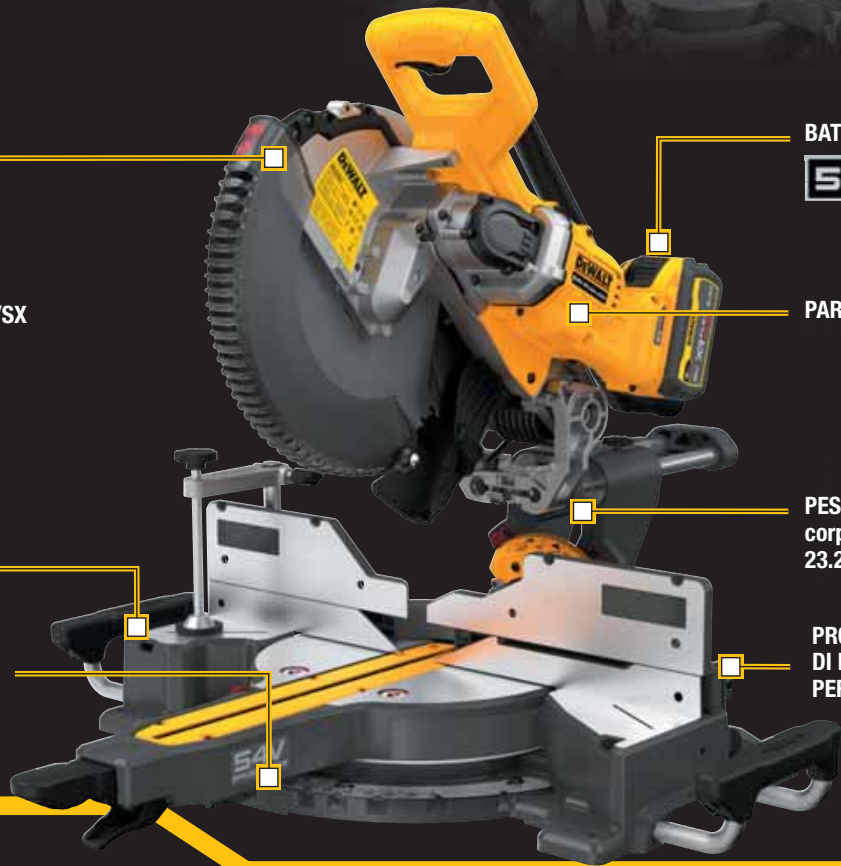

## DCS781X2-QW TRONCATRICE RADIALE 305MM 54V

- Doppia inclinazione della testa
- Tecnologia con frenata rigenerativa
- Base in alluminio rettificata
- Rotazione della tavola con punti prefissati e scala graduata in acciaio incisa
- Prolunghe del piano di lavoro con presa per il trasporto
- Partenza lenta
- Peso 23.2kg

**DOTAZIONE:**

2 batterie XR Flexvolt 9Ah,  
caricabatteria, lama per legno 305/30,  
60 denti DT99575-QZ,  
sacchetto raccogli-polvere, morsetto

	X	Y	X	Y	X	Y
90° 90°	278 mm	112 mm	310 mm	90 mm	19 mm	165 mm
45° 90°	197 mm	112 mm	219 mm	90 mm		
90° 45° dx	278 mm	60 mm	310 mm	54 mm		
45° 45° dx	296 mm	50 mm	310 mm	40 mm		

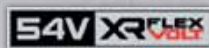

**1.459<sup>00</sup> €**

+ IVA



**NOVITÀ**

# ULTRA POTENZA + AUTONOMIA

**54V XR FLEX VOLT**

ACQUISTA UN ELETTROUTENSILE DELLA GAMMA 54V XR FLEXVOLT ADERENTE ALL'INIZIATIVA, ED AVRAI LA 3<sup>a</sup> BATTERIA XR FLEXVOLT DA 6.0AH

**OMAGGIO**



**DCB546-XJ  
BATTERIA 54V 6AH**

**NOVITÀ**



**1.459<sup>00</sup> €**  
+ IVA



**DCS781X2-QW  
TRONCATRICE RADIALE 305MM  
54V XR FV 9AH**



**1.035<sup>00</sup> €**  
+ IVA



**DCS777T2-QW  
TRONCATRICE RADIALE 216MM  
XR FV 6AH**



**1.145<sup>00</sup> €**  
+ IVA



**DCS727T2-QW  
TRONCATRICE RADIALE 250MM  
XR FV 6AH**



**1.210<sup>00</sup> €**  
+ IVA



**DCS7485T2-QW  
SEGA A BANCO 250MM  
XR FV 6AH**



**1.099<sup>00</sup> €**  
+ IVA



**DCH892X2-QW  
MARTELLO DEMOLITORE  
SDS-MAX 19.4J XR FV 9AH**



**949<sup>00</sup> €**  
+ IVA



**DCH832X2-QW  
MARTELLO DEMOLITORE  
SDS-MAX 10.5J XR FV 9AH**



**1.285<sup>00</sup> €**  
+ IVA



**DCH775X2-QW  
MARTELLO DEMO-PERFORATORE  
SDS-MAX 52MM 19.4J XR FV 9AH**



**1.240<sup>00</sup> €**  
+ IVA



**DCH735X2-QW  
MARTELLO DEMO-PERFORATORE  
SDS-MAX 48MM 13.3J XR FV 9AH**



**1.140<sup>00</sup> €**  
+ IVA



**DCH614X2-QW  
MARTELLO DEMO-PERFORATORE  
SDS-MAX 45MM 10.5J XR FV 9AH**



**1.085<sup>00</sup> €**  
+ IVA



**DCH481X2-QW  
MARTELLO DEMO-PERFORATORE  
SDS-MAX 40MM 6.1J XR FV 9AH**



**1.175<sup>00</sup> €**  
+ IVA



**DCH417X2-QW TASSELLATORE  
SDS-PLUS 32MM 4.5J XR FV 9AH  
DOPPIO MANDRINO + ACCESSORI**



**1.080<sup>00</sup> €**  
+ IVA



**DCH334X2-QW TASSELLATORE  
SDS-PLUS 30MM 3.5J XR FV 9AH  
DOPPIO MANDRINO**



**1.050<sup>00</sup> €**  
+ IVA



**DCH333X2-QW  
TASSELLATORE SDS-PLUS 30MM  
3.5J XR FV 9AH**



**955<sup>00</sup> €**  
+ IVA



**DCH323T2-QW  
TASSELLATORE SDS-PLUS 28MM  
2.8J XR FV 6AH**



DCG418X2-QW  
**820<sup>00</sup> €**  
+ IVA

DCG418T2-QW  
**713<sup>00</sup> €**  
+ IVA



**SMERIGLIATRICE ANGOLARE 125MM  
DCG418X2-QW XR FV 9AH  
DCG418T2-QW XR FV 6AH**

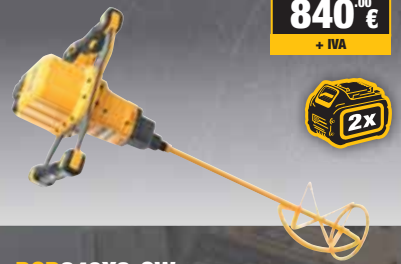

**840<sup>00</sup> €**  
+ IVA



**DCD240X2-QW  
MISCELATORE A DOPPIA  
IMPUGNATURA XR FV 9AH**



**795<sup>00</sup> €**  
+ IVA



**DCG200T2-QW  
SCANALATRICE 125MM  
XR FV 6AH**



**8€ WIRELESS  
TOOL CONTROL™**

**1.060<sup>00</sup> €**  
+ IVA

POSSIBILITÀ DI ALLOGGIARE  
LE BATTERIE XR FLEXVOLT  
15AH (DCB549-X.J)



**DCS691X2-QW  
TRONCATORE 230MM  
XR FV 9AH**



**940<sup>00</sup> €**  
+ IVA



**DCS398T2-QW  
SEGA ALLIGATOR 430MM  
XR FV 6AH**



DCS389X2-QW  
**825<sup>00</sup> €**  
+ IVA

DCS389T2-QW  
**720<sup>00</sup> €**  
+ IVA



**SEGA UNIVERSALE  
DCS389X2-QW XR FV 9AH  
DCS389T2-QW XR FV 6AH**



DCS579X2-QW  
**880<sup>00</sup> €**  
+ IVA

DCS579T2-QW  
**780<sup>00</sup> €**  
+ IVA



**SEGA CIRCOLARE Ø 190MM  
DCS579X2-QW XR FV 9AH  
DCS579T2-QW XR FV 6AH**



**750<sup>00</sup> €**  
+ IVA



**DCV586MT2-QW  
ASPIRATORE CLASSE M  
XR FV 6AH**

# BATTERIE E CARICABATTERIE

## DCB094K-QW ADATTATORE CARICABATTERIE USB 18V

- Collegato alla batteria alimenta dispositivi elettronici tramite cavo USB
- Collegato all'alimentatore in dotazione ha funzione di caricabatteria (carica una batteria 18V 5Ah in 65 min.)
- Doppia porta USB (1 type A e 1 type C)

DOTAZIONE: Cavo USB PD lunghezza 1 mt, alimentatore USB C 100W, gancio da cintura

**135<sup>.00</sup> €**  
+ IVA



**XR FLEX VOLT**

**209<sup>.00</sup> €**  
+ IVA



**DCB547G-XJ**  
**BATTERIA 54V XR FV 9AH**  
Serie G resistente a oli e solventi

**XR FLEX VOLT**

**400<sup>.00</sup> €**  
+ IVA



**DCB549-XJ**  
**BATTERIA XR FV 15AH**  
Compatibile con elettroutensili XR e XR FV

**POWERSTACK**

**99<sup>.00</sup> €**  
+ IVA



**NOVITÀ**

**DCBP034G-XJ**  
**BATTERIA POWERSTACK 18V**  
Serie G resistente a oli e solventi

**54V XR FLEX VOLT**  
**18V XR**

**125<sup>.00</sup> €**  
+ IVA



**DCB117-QW**  
**CARICABATTERIE RAPIDO**  
**18V-54V 12A**

**245<sup>.00</sup> €**  
+ IVA



**DCB104-QW**  
**CARICABATTERIE RAPIDO**  
**UNIVERSALE A 4 INGRESSI**

**115<sup>.00</sup> €**  
+ IVA



**DCB184G-XJ**  
**BATTERIA 18V XR 5AH**  
Serie G resistente a oli e solventi

**79<sup>.00</sup> €**  
+ IVA



**DCB183G-XJ**  
**BATTERIA 18V XR 2AH**  
Serie G resistente a oli e solventi

**91<sup>.00</sup> €**  
+ IVA



**DCB126G-XJ**  
**BATTERIA 12V XR 5AH**  
Serie G resistente a oli e solventi

**75<sup>.00</sup> €**  
+ IVA



**DCB124G-XJ**  
**BATTERIA 12V XR 3AH**  
Serie G resistente a oli e solventi

**54V XR FLEX VOLT**

Scegli il tuo  
**STARTER KIT**

**XR FLEX VOLT**  
**6AH**  
**379<sup>00</sup> €**  
+ IVA



**DCB118T2-QW**  
**STARTER KIT 54V 6AH**  
• 2 batterie XR FV 6 Ah  
• 1 caricabatterie rapido output 8A

**XR FLEX VOLT**  
**9AH**  
**479<sup>00</sup> €**  
+ IVA



**DCB118X2-QW**  
**STARTER KIT 54V 9AH**  
• 2 batterie XR FV 9 Ah  
• 1 caricabatterie rapido output 8A

**XR FLEX VOLT**  
**12AH**  
**600<sup>00</sup> €**  
+ IVA



**DCB118Y2-QW**  
**STARTER KIT 54V 12AH**  
• 2 batterie XR FV 12 Ah  
• 1 caricabatterie rapido output 8A

**54V XR FLEX VOLT**

Se vuoi completare  
la tua attrezzatura  
scegli:

**IL CORPO  
MACCHINA  
CHE FA PER TE**

**750<sup>00</sup> €**  
+ IVA



**DCH892N-XJ MARTELLLO  
DEMOLITORE SDS-MAX  
19.4J XR FV 9AH**

**529<sup>00</sup> €**  
+ IVA



**DCH832N-QW MARTELLLO  
DEMOLITORE SDS-MAX  
10.5J XR FV 9AH**

**960<sup>00</sup> €**  
+ IVA



**DCH775N-XJ MARTELLLO  
DEMOPERFORATORE SDS-  
MAX 52MM 19.4J**

**865<sup>00</sup> €**  
+ IVA



**DCH735N-XJ MARTELLLO  
DEMOPERFORATORE  
SDS-MAX 48MM 13.3J**

**765<sup>00</sup> €**  
+ IVA



**DCH614N-XJ MARTELLLO  
DEMOPERFORATORE  
SDS-MAX 45MM 10.5J**

**685<sup>00</sup> €**  
+ IVA



**DCH481N-XJ MARTELLLO  
DEMOPERFORATORE  
SDS-MAX 40MM 6.1J**

**739<sup>00</sup> €**  
+ IVA



**DCH417NT-XJ  
TASSELLATORE  
SDS-PLUS 32MM 4.5J**

**635<sup>00</sup> €**  
+ IVA



**DCH333NT-XJ  
TASSELLATORE SDS-PLUS  
30MM 3.5J**

**595<sup>00</sup> €**  
+ IVA



**DCH323NT-XJ  
TASSELLATORE SDS-PLUS  
28MM 2.8J**

# SOLUZIONE **XR 54V** CHE FA PER TE



**440<sup>.00</sup> €**  
+ IVA

**DCG440N-XJ**  
SMERIGLIATRICE  
ANGOLARE 180MM



**435<sup>.00</sup> €**  
+ IVA

**DCG418NT-XJ**  
SMERIGLIATRICE  
ANGOLARE 125MM



**475<sup>.00</sup> €**  
+ IVA

**DCG200NT-XJ**  
SCANALATRICE 125MM



**590<sup>.00</sup> €**  
+ IVA

**DCS691N-XJ**  
TRONCATORE 230MM

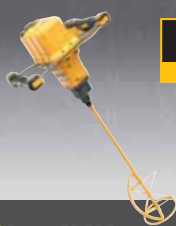

**460<sup>.00</sup> €**  
+ IVA

**DCD240N-XJ**  
MISCELATORE A DOPPIA  
IMPUGNATURA



**435<sup>.00</sup> €**  
+ IVA

**DCS389NT-XJ**  
SEGA UNIVERSALE



**530<sup>.00</sup> €**  
+ IVA

**DCS397N-XJ**  
SEGA ALLIGATOR 430MM



**475<sup>.00</sup> €**  
+ IVA

**DCS579NT-XJ**  
SEGA CIRCOLARE  
Ø 190MM



**645<sup>.00</sup> €**  
+ IVA

**DCS777N-XJ**  
TRONCATRICE RADIALE  
216MM



**815<sup>.00</sup> €**  
+ IVA

**DCS727N-XJ**  
TRONCATRICE RADIALE  
250MM

**NOVITÀ**



**1.059<sup>.00</sup> €**  
+ IVA

**DCS781N-XJ**  
TRONCATRICE RADIALE  
305MM



**480<sup>.00</sup> €**  
+ IVA

**DCC1054N-XJ**  
COMPRESSORE 10 LITRI

All'acquisto dello  
starter kit e di un  
corpo macchina

**IN  
DOTAZIONE  
A TUA SCELTA**

**OPPURE**



**CARICABATTERIA  
RAPIDO XR 12A  
DCB117-QW**

**OPPURE**



**VASCA FONDA  
CON RUOTE TSTAK  
DWST83347-1**



**BATTERIA  
XR FLEXVOLT 6.0AH  
DCB546-XJ**

**POWER STACK**™  
BATTERY TECHNOLOGY

THE  
**NEXT DIMENSION**  
IN **POWER**™



## POWERSTACK 18V

è la prima batteria al mondo, per  
elettroutensili, ad usare la tecnologia  
delle celle a sacchetto (Pouch Cell).  
Mai vista una batteria così!



**50%\***  
PIÙ POTENTE

+

**2x\***  
DURATA DELLA  
VITA UTILE

+

**DEWALT**  
**3**  
YEAR  
GUARANTEE  
\*\*\*

La batteria compatta POWERSTACK è compatibile con tutta la gamma di oltre 250 elettroutensili DEWALT XR 18V





# SCEGLI LA TUA POWERSTACK



## COMPATTEZZA

**25%\***  
PIÙ COMPATTA



### DCBP034-XJ BATTERIA 18V COMPATTA POWERSTACK

Design compatto e leggero.  
Scocca gommata, indicatore di carica a LED, peso 0,32 Kg.

## AUTONOMIA

**50%\***  
DI LAVORO IN  
PIÙ PER CARICA



**5<sup>NEW</sup> AH**

### DCBP518-XJ BATTERIA 18V 5AH POWERSTACK

Consente di lavorare col 50% in più di autonomia.  
Scocca gommata, indicatore di carica a LED, peso 0,68 Kg.

\* 50% PIÙ POTENTE, 2X DURATA VITA UTILE, 25% PIÙ COMPATTA: DCBP034 rispetto DBC183. 50% DI LAVORO IN PIÙ PER CARICA: energia utilizzabile batteria DCBP518 rispetto alle batterie DEWALT XR® 5Ah o inferiori non in applicazione.

## QUALE POTENZA TI SERVE?

**12V XR**

**18V XR**

POWERSTACK

**54V XR FLEX VOLT**

**349<sup>.00</sup> €**  
+ IVA



**PIU' COMPATTEZZA**

**DCD805E2T-QW**  
TRAPANO AVVITATORE  
CON PERCUSSIONE  
18V **POWERSTACK**

- Potenza 90Nm
- 2 velocità
- Peso 1,2 kg

DOTAZIONE: 2 batterie 18V **POWERSTACK**, caricabatterie 2A, valigetta TSTAK

**489<sup>.00</sup> €**  
+ IVA



**PIU' AUTONOMIA**

**DCD805H2T-QW**  
TRAPANO AVVITATORE  
CON PERCUSSIONE 18V  
**POWERSTACK 5AH**

- Potenza 90Nm
- 2 velocità
- Peso 1,2 kg

DOTAZIONE: 2 batterie 18V **POWERSTACK 5Ah**, caricabatterie 4A, valigetta TSTAK

**599<sup>.00</sup> €**  
+ IVA



**PIU' POTENZA**

**DCD999H2T-QW**  
TRAPANO AVVITATORE  
CON PERCUSSIONE XRP  
18V **POWERSTACK 5AH**

- Max coppia 112Nm
- 3 velocità 0-450/1300/2000 giri/min
- Peso 1,61 kg

DOTAZIONE: 2 batterie 18V **POWERSTACK 5Ah**, caricabatterie 4A, valigetta TSTAK

**DCBP518-XJ**  
BATTERIA 18V **POWERSTACK**

Batteria 5Ah con tecnologia delle celle a sacchetto che consente di lavorare col 50% in più di autonomia. Scocca gommata per una maggiore resistenza agli urti e una lunga durata. Indicatore di carica LED. Peso 0.68 kg

**169<sup>.00</sup> €**  
+ IVA

**POWERSTACK**™





**550<sup>00</sup> €**  
+ IVA



**DCF921H2T-QW**  
**AVVITATORE A IMPULSI 1/2"**  
**4 MODALITÀ (PONTEGGIO)**  
**406NM 18V POWERSTACK 5AH**

- 0-3550 impulsi/min
- 2 velocità: 0-1400-2500 giri/min
- Max Ø bullone M20
- 3 luci led
- Peso 1.1 kg\*

DOTAZIONE: 2 batterie 18V **POWERSTACK 5AH**, caricabatterie 4A, TSTAK



**575<sup>00</sup> €**  
+ IVA



**DCF891H2T-QW**  
**AVVITATORE A IMPULSI 1/2"**  
**4 MODALITÀ 812NM**  
**18V POWERSTACK 5AH**

- 0-3250 impulsi/min
- 0- velocità: 0-2000 giri/min
- Max Ø bullone M24
- 3 luci led
- Peso 1.7 kg\*

DOTAZIONE: 2 batterie 18V **POWERSTACK 5AH**, caricabatterie 4A, TSTAK



**599<sup>00</sup> €**  
+ IVA



**DCF900H2T-QW**  
**AVVITATORE A IMPULSI 1/2"**  
**4 MODALITÀ 1355 NM**  
**18V POWERSTACK 5AH**

- 0-2200 impulsi/min
- 3 velocità 0-650-1250-2300 giri/min
- Max Ø bullone M30
- Luce led
- Peso 2.9 kg\*

DOTAZIONE: 2 batterie 18V **POWERSTACK 5AH**, caricabatterie 4A, TSTAK



**599<sup>00</sup> €**  
+ IVA



**DCH273H2T-QW**  
**TASSELLATORE SDS-PLUS 2.1J**  
**18V POWERSTACK 5AH**

- 3 Modalità
- Max Ø 24mm
- Energia del colpo 2.1J (EPTA 05/2009)
- Percussioni/min 4600

DOTAZIONE: 2 batterie 18V **POWERSTACK 5AH**, caricabatterie 4A, TSTAK



**540<sup>00</sup> €**  
+ IVA



**DCG409H2T-QW**  
**SMERIGLIATRICE 125MM**  
**18V POWERSTACK 5AH**

- Velocità 9000 giri/min
- Freno motore elettronico anti "Kick Back"
- Frizione elettronica
- Impugnatura gommata

DOTAZIONE: 2 batterie 18V **POWERSTACK 5AH**, caricabatteria 4A, TSTAK



**635<sup>00</sup> €**  
+ IVA



**DCS570H2T-QW**  
**SEGA CIRCOLARE 184MM**  
**18V POWERSTACK 5AH**

- Velocità 5500 giri/min
- Max profondità taglio 90°/45° 65/45mm
- Max inclinazione lama fino a 57°

DOTAZIONE: 2 batterie 18V **POWERSTACK 5AH**, caricabatteria 4A, TSTAK



**640<sup>00</sup> €**  
+ IVA



**DCS573H2T-QW**  
**SEGA CIRCOLARE 190MM**  
**18V POWERSTACK 5AH**

- Velocità 5.500 giri/minuto
- Max profondità taglio 90°/45° 67/51mm
- Max inclinazione lama fino a 57°
- Freno elettronico
- Luce LED

DOTAZIONE: 2 batterie 18V **POWERSTACK 5AH**, caricabatteria 4A, TSTAK



**590<sup>00</sup> €**  
+ IVA



**DCS386H2T-QW**  
**SEGA UNIVERSALE**  
**18V POWERSTACK 5AH**

- Corse/min: 0-3.000
- Lunghezza corsa 28.6mm
- Aggancio rapido della lama
- Luce LED

DOTAZIONE: 2 batterie 18V **POWERSTACK 5AH**, caricabatteria 4A, TSTAK



**665<sup>00</sup> €**  
+ IVA



**DCS367H2T-QW**  
**SEGA UNIVERSALE COMPATTA**  
**18V POWERSTACK 5AH**

- Corse/Min: 0-2900
- Lunghezza corsa 28.6 mm
- Aggancio rapido della lama
- Luce LED

DOTAZIONE: 2 batterie 18V **POWERSTACK 5AH**, caricabatteria 4A, TSTAK

**DCBP034-XJ**  
**BATTERIA 18V**  
**POWERSTACK**  
**(con celle a sacchetto)**

Design compatto e leggero, scocca gommata per una maggior resistenza agli urti e una lunga durata, indicatore di carica a LED, peso 0,32 kg.

**99<sup>.00</sup> €**  
 + IVA

POWERSTACK™



**THE TOUGH GET TOUGHER™**

**408<sup>.00</sup> €**  
 + IVA



**DCH172E2T-QW TASSELLATORE SDS-PLUS**  
**2 MODALITÀ 18V POWERSTACK**

- Potenza colpo (EPTA 05/2009) 1.4J
- Max Ø foratura 16mm
- Percussioni/min 0-4980
- Peso 2.1 kg\*

DOTAZIONE: 2 batterie 18V **POWERSTACK**, caricabatterie, valigetta TSTAK

**349<sup>.00</sup> €**  
 + IVA



**DCD805E2T-QW TRAPANO AVVITATORE**  
**CON PERCUSSIONE 18V POWERSTACK**

- Potenza 90Nm
- Peso 1,2 kg\*

DOTAZIONE: 2 batterie 18V **POWERSTACK**, caricabatterie, valigetta TSTAK

**329<sup>.00</sup> €**  
 + IVA



**DCD800E2T-QW TRAPANO AVVITATORE 18V**  
**POWERSTACK**

- Potenza 90Nm
- Peso 1,2 kg\*

DOTAZIONE: 2 batterie 18V **POWERSTACK**, caricabatterie, valigetta TSTAK

**455<sup>.00</sup> €**  
 + IVA



**DCS438E2T-QW MINITRONCATRICE**

- Velocità 20.000 giri/min
- Ø disco/foro 76/10mm
- Max profondità taglio 22mm
- Peso 0.94 kg\*

DOTAZIONE: 2 batterie 18V **POWERSTACK**, cuffia aspirazione, disco abrasivo, disco diamantato piastrelle, disco diamantato multimaterial, caricabatteria, valigetta TSTAK

\* Il peso indicato è riferito al solo corpo macchina

# GAMMA

## 250+ 18V XR

PARTE DEL SISTEMA 18V XR



**359<sup>.00</sup> €**

+ IVA

**2x**

206NM

**1/4"**

### DCF850E2T-QW AVVITATORE A IMPULSI 1/4" 3 VELOCITÀ 206NM 18V POWERSTACK

- 0-3800 impulsi/min
- Max ø bullone M16 - 3 luci led
- Peso 0.9 kg\*

DOTAZIONE: 2 batterie 18V POWERSTACK, caricabatterie, valigetta TSTAK



**430<sup>.00</sup> €**

+ IVA

**2x**

406NM

610NM

**1/2"**

**PRECISION  
WRENCH**

### DCF921E2T-QW AVVITATORE A IMPULSI 1/2" 4 MODALITÀ (PONTEGGIO) 406NM 18V POWERSTACK

- 0-3550 impulsi/min
- 3 luci led
- Peso 1.1 kg\*

DOTAZIONE: 2 batterie 18V POWERSTACK, caricabatterie, valigetta TSTAK

### KIT 18V POWERSTACK DCK2052H1E1T-QW

- DCD999 Trapano a percussione 3 velocità 112Nm
- DCF850 Avvitatore impulsi 1/4" 206Nm
- 1 batteria 18V POWERSTACK 5Ah
- 1 batteria 18V POWERSTACK compatta
- Caricabatterie 4A
- Valigetta TSTAK

**695<sup>.00</sup> €**

+ IVA

**2x**



**NOVITÀ**



**585<sup>.00</sup> €**

+ IVA

**2x**

### KIT 18V POWERSTACK DCK2050E2T-QW

- DCD805 Trapano a percussione 90Nm
- DCF850 Avvitatore impulsi 1/4" 206Nm
- 2 Batterie 18V POWERSTACK
- Caricabatterie
- Valigetta TSTAK

\* Il peso indicato è riferito al solo corpo macchina

### DCG409VSNT-XJ SMERIGLIATRICE ANGOLARE 125MM BRUSHLESS VELOCITÀ VARIABILE

- 6 Velocità regolabili da 3000 a 9000 giri/min
- Protezione da sovraccarico
- Freno motore elettronico
- Anti «Kick Back»
- Frizione Elettronica
- Peso 1.8 kg\*

**DOTAZIONE:**  
Impugnatura laterale  
Protezioni per sbavo e taglio  
Chiave di servizio  
Valigetta TSTAK



**250<sup>00</sup> €**  
+ IVA

0€ WIRELESS TOOL CONTROL

**NOVITÀ**

### DCS496N-XJ CESOIA PER TAGLI CURVI E LAMIERE ONDULATE

- Testa orientabile 360°
- Max capacità di taglio 1.3mm
- Minimo raggio di curvatura 25.4 mm
- Interruttore a velocità variabile
- Luce Led
- Peso 1.5 kg\*

In scatola di cartone



**295<sup>00</sup> €**  
+ IVA

**NOVITÀ**

### DCD800P2T-QW TRAPANO AVVITATORE BRUSHLESS 18V XR 5AH

- Potenza 90Nm
- Velocità 0-650/2.000 giri/min

**DOTAZIONE:**  
2 batterie 18V XR 5Ah,  
caricabatteria, TSTAK

### DCD805P2T-QW TRAPANO AVVITATORE A PERCUSSIONE BRUSHLESS 18V XR 5AH

- Potenza 90Nm
- Velocità 0-650/2.000 giri/min
- Percussioni 0-34.000 minuto

**DOTAZIONE:**  
2 batterie 18V XR 5Ah,  
caricabatteria, TSTAK



DCD800P2T-QW  
**359<sup>00</sup> €**  
+ IVA

DCD805P2T-QW  
**379<sup>00</sup> €**  
+ IVA

### DCD708D2T-QW TRAPANO AVVITATORE BRUSHLESS 18V XR 2AH

### DCD709D2T-QW TRAPANO AVVITATORE A PERCUSSIONE BRUSHLESS 18V XR 2AH



DCD708D2T-QW  
**205<sup>00</sup> €**  
+ IVA

DCD709D2T-QW  
**225<sup>00</sup> €**  
+ IVA

SERIE COMPACT

MANDRINO  
IN METALLO!



### DCD1623X2G-QW TRAPANO A SUPPORTO MAGNETICO 18V BL

- 2 velocità meccaniche con regolazione elettronica 130-420/250-810 giri/min
- Doppio senso di rotazione
- Attacco Weldon 19mm
- Max diametro di foratura 50mm
- Max profondità di taglio 50mm
- Sistema di sicurezza Antirotazione
- Magnete permanente regolabile in 3 posizioni
- Peso 14.3 kg
- Altezza 345.4 mm
- Illuminazione a led

**2.199<sup>00</sup> €**  
+ IVA

**DOTAZIONE:**  
mandrino a cremagliera  
std 13mm, serbatoio  
per lubrificante,  
catena di sicurezza,  
2 batterie FV 9Ah G,  
caricabatteria,  
valigetta

**PERFORM  
PROTECT**





**DCG405P2-QW**  
**SMERIGLIATRICE 125MM**  
**BRUSHLESS 18V XR 5 AH**

- Velocità a vuoto 9000 giri/min
- Interruttore a slitta
- Vibrazioni 4.4 m/s<sup>2</sup>
- Peso 2.6 kg

DOTAZIONE: 2 batterie XR 5Ah,  
caricabatterie, valigetta TSTAK

**340<sup>.00</sup> €**  
+ IVA



**432<sup>.00</sup> €**  
+ IVA



**DCH172P2-QW**  
**TASSELLATORE SDS-PLUS**  
**1.4J 18V XR 5 AH**

- 2 Modalità
- Max Ø16 mm
- Energia del colpo 1.4J (EPTA 05/2009)
- Percussioni/min 4980

DOTAZIONE: 2 batterie XR 5Ah,  
caricabatterie, valigetta TSTAK

**DCH273P2T-QW**  
**TASSELLATORE SDS-PLUS**  
**2.1J 18V XR 5 AH**

- 3 Modalità
- Max Ø 24mm
- Energia del colpo 2.1J (EPTA 05/2009)
- Percussioni/min 4600

DOTAZIONE: 2 batterie XR 5Ah,  
caricabatterie, valigetta TSTAK

**489<sup>.00</sup> €**  
+ IVA



**559<sup>.00</sup> €**  
+ IVA



**DCH274P2T-QW**  
**TASSELLATORE SDS-PLUS**  
**2.1J 18V XR 5 AH**  
**DOPPIO MANDRINO**

- 3 Modalità
- Max Ø 24mm
- Energia del colpo 2.1J (EPTA 05/2009)
- Percussioni/min 4600

DOTAZIONE: mandrino autoserrante  
2 batterie XR 5Ah, caricabatterie,  
valigetta TSTAK

# LE ABBINATE XR 18V DeWALT

**1.135<sup>00</sup> €**  
+ IVA

**18V XR**  
BRUSH-LESS

## KIT 18V XR 5AH DCK353P4T-IT

- DCH273 Tassellatore SDS-Plus
- DCD796 Trapano a percussione
- DCG405 Smerigliatrice 125mm
- 4 Batterie XR 18V 5AH
- 2 Caricabatterie
- 3 Valigette TSTAK



## KIT 18V XR 5AH DCK2153P2T-IT

- DCD796 Trapano a percussione
- DCG405 Smerigliatrice 125mm
- 2 Batterie XR 18V 5AH
- Caricabatterie rapido
- 2 Valigette TSTAK

**580<sup>00</sup> €**  
+ IVA

**18V XR**  
BRUSH-LESS



**609<sup>00</sup> €**  
+ IVA

**18V XR**  
BRUSH-LESS

## KIT 18V XR 5AH DCK922HDP2-IT

- DCF922 Avvitatore impulsi 812NM
- DCD805 Trapano a percussione
- 2 Batterie XR 18V 5AH
- Caricabatterie rapido
- 2 Valigette TSTAK





# AVVITATORI A IMPULSI

## DCF840D2T-QW AVVITATORE A IMPULSI 1/4" 192NM 18V XR 2AH

- 0-3200 impulsi/min
- Max ø bullone M14
- 3 luci led
- Peso 0.9Kg\*

DOTAZIONE:  
2 batterie 18V XR  
2Ah, caricabatterie,  
valigetta TSTAK



## DCF850P2T-QW AVVITATORE A IMPULSI 1/4" 3 VELOCITÀ 206NM 18V XR 5AH

- 0-3800 impulsi/min
- Max ø bullone M16
- 3 luci led
- Peso 0.9Kg\*

DOTAZIONE:  
2 batterie 18V XR 5Ah,  
caricabatterie,  
valigetta TSTAK



## DCF922P2T-QW AVVITATORE A IMPULSI 1/2" 4 MODALITÀ (VITI) 406NM 18V XR 5AH

- 0-3550 impulsi/min
- 3 luci led
- Peso 1.1Kg\*

DOTAZIONE:  
2 batterie 18V XR 5Ah,  
caricabatterie,  
valigetta TSTAK



## DCF891P2T-QW AVVITATORE A IMPULSI 1/2" 812NM 18V XR 5AH

- 0-3250 impulsi/min
- 3 luci led
- 4 modalità
- Peso 1.7Kg\*

DOTAZIONE:  
2 batterie 18V XR  
5Ah, caricabatterie,  
valigetta TSTAK



## DCF900P2T-QW AVVITATORE A IMPULSI 1/2" 18V XR BRUSHLESS

- 4 modalità
- 3 velocità: 0-650/135Nm,  
0-1250/813Nm, 0-2300/1355Nm
- Svitatura 1898Nm
- Max Ø bullone M30
- Colpi al minuto 0-2200
- Peso 2.9 kg (solo corpo macchina)

DOTAZIONE:  
2 batterie 18V XR 5Ah, caricabatterie,  
valigetta TSTAK



18V XR  
BRUSHLESS

PRECISION  
WRENCH

PERFORM  
PROTECT



**18V XR**

**DCF897X2-IT**  
**AVVITATORE AD IMPULSI**  
**3/4" 18V XR FV 9AH**

- Attacco 3/4"
- Velocità (giri/min)  
0-400 / 1200 / 1900
- Max Ø bullone M20

DOTAZIONE:  
 2 batterie XR FV 9AH,  
 caricabatterie, valigetta  
 TSTAK VI fondo



**835.<sup>00</sup> €**

+ IVA

**3/4"**

950NM

1825NM



**DCF900P2G-QW**  
**AVVITATORE AD IMPULSI**  
**1/2" 18V XR 5AH**

- Attacco 1/2"
- Coppia 135/813/1355 Nm
- Colpi al minuto 0-2200
- 3 velocità (giri/min)  
0-650 / 1250 / 2300
- Max Ø bullone M30

DOTAZIONE: 2 batterie 18V XR  
 "G" 5Ah, caricabatteria, schiuma  
 preformata per cassettera,  
 sovrascocca in gomma



**499.<sup>00</sup> €**

+ IVA

**1/2"**

1355NM

1895NM



**DCF891P2G-QW**  
**AVVITATORE AD IMPULSI**  
**1/2" 812NM 18V XR**  
**5AH CON BATTERIE "G"**

- Attacco 1/2" HOG RING
- Colpi/min 0-3550
- Max Ø bullone M24

DOTAZIONE: 2 batterie 18V XR  
 "G" 5Ah, caricabatteria,  
 schiuma preformata per  
 cassettera, sovrascocca  
 in gomma



**475.<sup>00</sup> €**

+ IVA

**1/2"**

812NM

1894NM



**18V XR**

**DCF901P1G-QW**  
**AVVITATORE AD IMPULSI**  
**1/2" 340NM 12V XR**  
**5AH CON BATTERIE "G"**

- Attacco 1/2"
- Max Ø bullone M16

DOTAZIONE: 1 batteria 12V XR  
 "G" 5Ah, caricabatteria,  
 schiuma preformata  
 per cassettera,  
 sovrascocca in gomma



**290.<sup>00</sup> €**

+ IVA

**1/2"**

340NM

500NM



**12V XR**

**DCF903P1G-QW**  
**AVVITATORE AD IMPULSI**  
**3/8" 340NM 12V XR**  
**5AH CON BATTERIE "G"**

- Attacco 3/8"
- Max Ø bullone M16

DOTAZIONE: 1 batteria 12V XR  
 "G" 5Ah, caricabatteria,  
 schiuma preformata  
 per cassettera,  
 sovrascocca in gomma



**290.<sup>00</sup> €**

+ IVA

**3/8"**

340NM

500NM



**12V XR**

# AVVITATORI AD IMPULSI SERIE "G"

dedicati al settore Automotive / Industria



**AVVITATORI AD IMPULSI**  
**DCF901P1G**    **DCF891P2G**  
**DCF903P1G**    **DCF900P2G**  
dotazione      dotazione  
1 batteria      2 batterie  
XR 12V "G" 5Ah    XR 12V "G" 5Ah



**STIVALE IN GOMMA**  
evita danneggiamento del materiale su cui operi e preserva l'utensile in caso di cadute o contatto diretto con olii/solventi



**BATTERIE XR 12V E XR 18V SERIE "G"**  
scocca in GFN (Glass-Filled Nylon) resistente alla maggior parte di olii e solventi. Maggiore resistenza a colpi e cadute. Gommatura esterna per preservare le superfici su cui si lavora



**SCHIUMA PREFORMATA PER CASSETTIERE**

schiuma con scomparti per avvitatore impulsivi e batterie da riporre all'interno dei cassettei dei carrelli (modulare carrelli USAG e Facom)

## STIVALI IN GOMMA PER AVVITATORI AD IMPULSI

Evita danneggiamento del materiale su cui operi e preserva l'utensile in caso di cadute o contatto diretto con olii/solventi

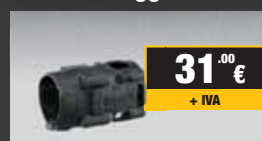

**31<sup>.00</sup> €**  
+ IVA

**PB900.899-QZ**

- idoneo per DCF900

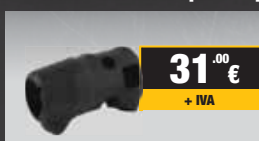

**31<sup>.00</sup> €**  
+ IVA

**PB891.92-QZ**

- idoneo per DCF891



**27<sup>.00</sup> €**  
+ IVA

**PB901.03-QZ**

- idoneo per DCF901/DCF903



**27<sup>.00</sup> €**  
+ IVA

**PB850-QZ**

- idoneo per DCF850

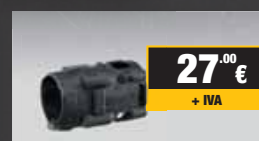

**27<sup>.00</sup> €**  
+ IVA

**PB921.22.23-QZ**

- idoneo per DCF921/DCF922

## SISTEMA MODULARE AD ANGOLO

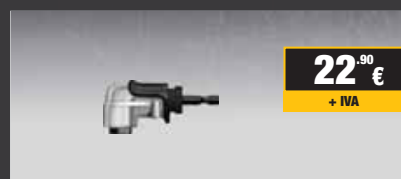

**22<sup>.90</sup> €**  
+ IVA

**DT20503-QZ TESTA AD ANGOLO ULTRA COMPATTA**

- Attacco 1/4" magnetico
- Coppia massima 43Nm



**26<sup>.50</sup> €**  
+ IVA

**DT20500-QZ TESTA AD ANGOLO CON IMPUGNATURA**

- Attacco 1/4" magnetico
- Coppia massima 43Nm



**39<sup>.50</sup> €**  
+ IVA

**DT20501-QZ TESTA AD ANGOLO CON IMPUGNATURA ED ALBERO FLESSIBILE**

- Attacco 1/4" magnetico
- Coppia massima 43Nm

## ACCESSORI AVVITATORI A IMPULSI



**DT50050-QZ**  
**68<sup>.00</sup> €**  
+ IVA

**10 PEZZI**

**SET FORARE METALLO**

- Punta Titanium metallo attacco 1/4" Ø: 3, 3.2, 3.5, 4, 4.5, 5, 6, 8, 10, 12mm



**DT70523T-QZ**  
**22<sup>.50</sup> €**  
+ IVA

**32 PEZZI**

**SET AVVITARE**

- Inserti 25mm: PH1, 2, 3 - PZ1, 2, 3 - SL6, 8 - T10, 15, 20, 25, 27, 30, 40 Porta inserti magnetico



**EXTREME**

Codici disponibili a Listino pag. 124

Lunghezza 38mm



**RESISTENZA 700Nm**

Lunghezza 78mm



**BUSSOLE A TESTA ESAGONALE ATTACCO 1/2"**

- Lunghezza 38mm Ø: 12, 13, 14, 15, 16, 17, 18, 19, 21, 22, 24mm
- Lunghezza 78mm Ø: 17, 18, 19, 21, 22, 24mm

**12V / 18V**
**200<sup>.00</sup> €**  
+ IVA

**DCL045-XJ**
**LAMPADA SOTTOCOFANO 12/18V XR**

- Compatibilità batterie XR 12V e 18V
- LED azionabili separatamente
- Ganci ruotabili
- Temperatura colore: 5000K
- Funzionamento con batteria 12/18V XR
- Luminosità: 800/1650 Lm
- Pieghevole
- Lunghezza utile 1.3-1.9 mt

Versione in scatola di cartone senza batterie e caricabatteria

**18V XR**  
BRUSH-LESS

**465<sup>.00</sup> €**  
+ IVA

**18V XR**  
BRUSH-LESS

**465<sup>.00</sup> €**  
+ IVA

**DCM849P2-QW**
**LUCIDATRICE ROTATORIA 180MM 18V XR 5AH**

- Motore BRUSHLESS
- Velocità 800 - 2000 opm
- Ø max platorello 180mm

DOTAZIONE: 2 batterie XR 18V 5Ah, caricabatterie, platorello in gomma da 180mm, impugnatura laterale dritta, Soft bag

**DCM848P2-QW**
**LUCIDATRICE ROTO ORBITALE 125MM 18V XR 5AH**

- Motore BRUSHLESS
- Orbita 15mm
- Velocità 2000 - 5500 opm
- Ø max platorello 125mm

DOTAZIONE: 2 batterie XR 18V 5Ah, caricabatterie, platorello in gomma da 125mm, impugnatura laterale dritta, Soft bag

**235<sup>.00</sup> €**  
+ IVA

**DWP849X-QS**
**LUCIDATRICE 1250W**

- Diametro 150-180mm
- Velocità variabile 0-600 / 3500 giri/min
- Filetto albero M14

DOTAZIONE: platorello in gomma da 180mm con attacco in velcro, tampone di lana 180mm con velcro, impugnatura laterale dritta, impugnatura a D

**81<sup>.00</sup> €**  
+ IVA

**DWD014S-QS**
**TRAPANO ROTATIVO 550W**

- Velocità 0-2800 giri/min
- Coppia 7.9Nm
- Mandrino autoserrante 1.0-10mm

# NUOVA GAMMA CRICCHETTI BRUSHLESS

Nuova gamma di cricchetti disponibile nelle versioni XR 12V o 18V con attacchi 1/4" 1/2" 3/8" e differenti lunghezze della testa. Potenti, leggeri e compatti, grazie alla forma in linea e alla testa ribassata (23 o 30mm) sono ideali per avviature in spazi ristretti.

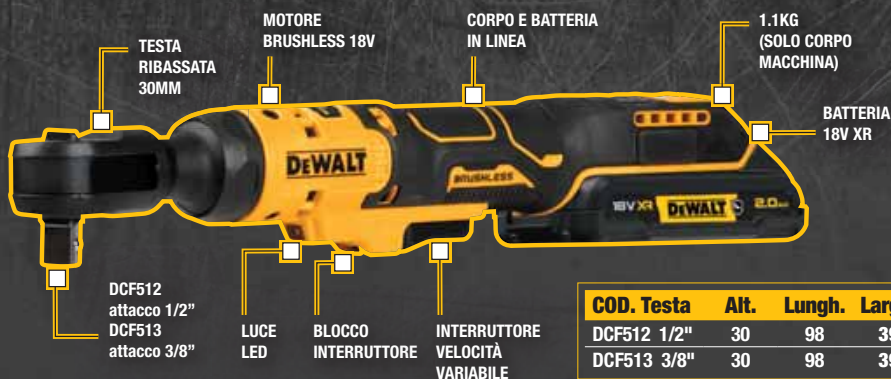

COD. Testa	Alt.	Lungh.	Largh.
DCF512 1/2"	30	98	39
DCF513 3/8"	30	98	39



**285<sup>00</sup> €**  
+ IVA

12"

**DCF512D1-QW**  
**CRICCHETTO ATTACCO 1/2" 18V XR**

Dotazione: 1 batteria XR 18V 2Ah, caricabatteria, borsa in cordura



**285<sup>00</sup> €**  
+ IVA

12"

**285<sup>00</sup> €**  
+ IVA

38"

**DCF512D1G-QW / DCF513D1G-QW**  
**CRICCHETTO 18V XR serie "G"**

Dotazione: 1 batteria XR 18V 2Ah serie G, caricabatteria, schiuma preformata per cassettiere



**199<sup>00</sup> €**  
+ IVA

12"

**199<sup>00</sup> €**  
+ IVA

38"

**DCF512N-XJ / DCF513N-XJ**  
**CRICCHETTO 18V XR**

Senza batterie e caricabatteria in scatola di cartone



COD. Testa	Alt.	Lungh.	Largh.
DCF504 1/4"	23	71	30
DCF503 3/8"	30	98	39
DCF503E 3/8"	30	198	39



**220<sup>00</sup> €**  
+ IVA

3/8"

**DCF503EN-XJ**  
**CRICCHETTO ATTACCO 3/8" 12V XR**

**TESTA LUNGA** Senza batterie e caricabatteria in scatola di cartone



**290<sup>00</sup> €**  
+ IVA

3/8"

**290<sup>00</sup> €**  
+ IVA

14"

**DCF503L1G-QW / DCF504L1G-QW**  
**CRICCHETTO 12V XR serie "G"**

Dotazione: 1 batteria XR 12V 3Ah serie "G", caricabatteria, schiuma preformata per cassettiere



**250<sup>00</sup> €**  
+ IVA

3/8"

**250<sup>00</sup> €**  
+ IVA

14"

**DCF503D1-QW / DCF504D1-QW**  
**CRICCHETTO 12V XR**

Dotazione: 1 batteria XR 12V 2Ah, caricabatteria, borsa in cordura



**195<sup>00</sup> €**  
+ IVA

3/8"

**195<sup>00</sup> €**  
+ IVA

14"

**DCF503N-XJ / DCF504N-XJ**  
**CRICCHETTO 12V XR**

Senza batterie e caricabatteria in scatola di cartone

**SCEGLI LA  
SOLUZIONE  
18V XR CHE  
FA PER TE**

**18V**  
BRUSHLESS **XR**



## STARTER KIT

Composti da:  
Caricabatteria +  
Batterie 18V XR

**DCB1104H2-QW**  
BATTERIA 18V XR  
5.0AH **POWERSTAK**

**359<sup>00</sup> €**  
+ IVA



**DCB1102E2-QW**  
BATTERIA 18V XR  
**POWERSTAK**

**199<sup>00</sup> €**  
+ IVA



**DCB1104P3-QW**  
BATTERIA 18V  
XR 5.0AH

**275<sup>00</sup> €**  
+ IVA



**DCB1104D2-QW**  
BATTERIA 18V  
XR 2.0AH

**145<sup>00</sup> €**  
+ IVA



Se vuoi completare  
la tua attrezzatura  
scegli:

**IL CORPO  
MACCHINA  
CHE FA PER TE**

**230<sup>00</sup> €**  
+ IVA



**DCG409NT-XJ**  
SMERIGLIATRICE 125MM  
potenza resa 1553W

**NOVITÀ**

**250<sup>00</sup> €**  
+ IVA



**DCG409VSNT-XJ**  
SMERIGLIATRICE ANGOLARE 125MM  
BRUSHLESS VELOCITÀ VARIABILE

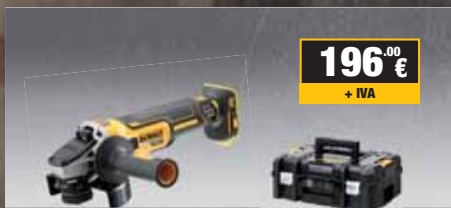

**196<sup>00</sup> €**  
+ IVA

**DCG405NT-XJ**  
SMERIGLIATRICE ANGOLARE 125MM  
potenza resa 800W



**246<sup>00</sup> €**  
+ IVA

**DCG405FNT-XJ**  
SMERIGLIATRICE ANGOLARE 125MM  
A TESTA PIATTA

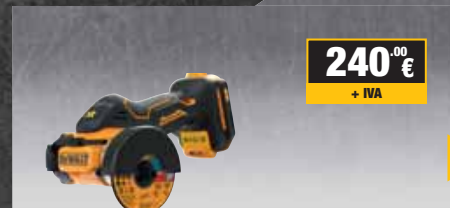

**240<sup>00</sup> €**  
+ IVA

**DCS438N-XJ**  
MINITRONCATRICE BRUSHLESS\*  
76MM

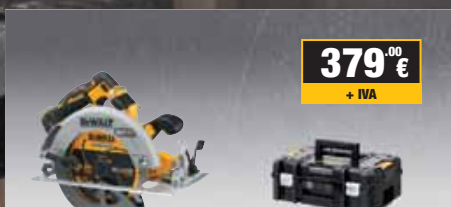

**379<sup>00</sup> €**  
+ IVA

**DCS573NT-XJ**  
SEGA CIRCOLARE 190MM  
18V XR

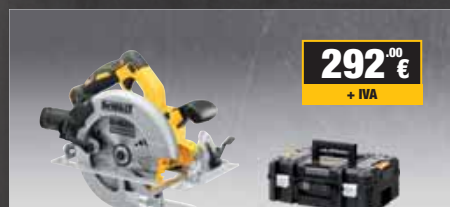

**292<sup>00</sup> €**  
+ IVA

**DCS570NT-XJ**  
SEGA CIRCOLARE 184MM

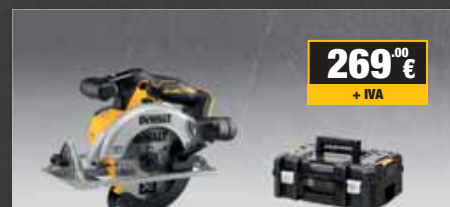

**269<sup>00</sup> €**  
+ IVA

**DCS565NT-XJ**  
SEGA CIRCOLARE COMPATTA  
165MM

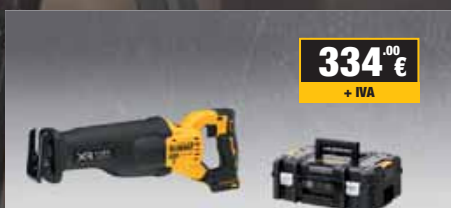

**334<sup>00</sup> €**  
+ IVA

**DCS386NT-XJ**  
SEGA UNIVERSALE



**322<sup>00</sup> €**  
+ IVA

**DCS382N-XJ**  
SEGA UNIVERSALE\*

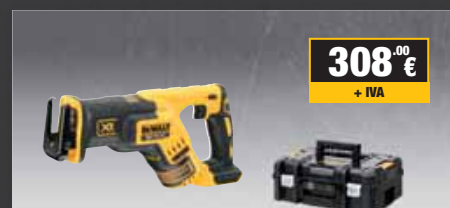

**308<sup>00</sup> €**  
+ IVA

**DCS367NT-XJ**  
SEGA UNIVERSALE COMPATTA



**295<sup>00</sup> €**  
+ IVA

**NOVITÀ**  
**DCS496N-XJ**  
CESOIA PER TAGLI CURVI  
E LAMIERE ONDULATE\*

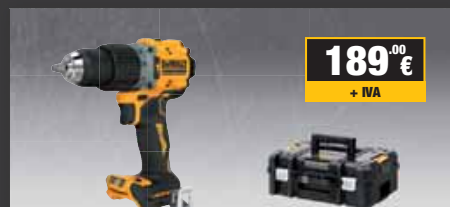

**189<sup>00</sup> €**  
+ IVA

**DCD805NT-XJ**  
TRAPANO A PERCUSSIONE  
90NM

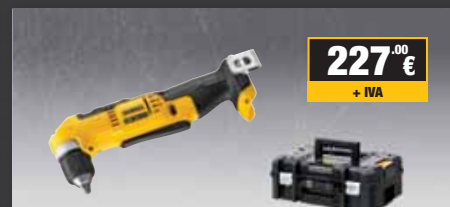

**227<sup>00</sup> €**  
+ IVA

**DCD740NT-XJ**  
TRAPANO AD ANGOLO

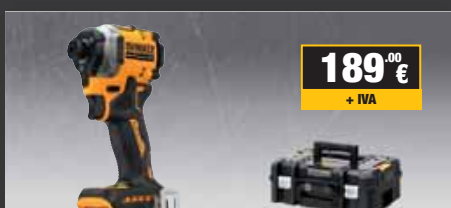

**189<sup>00</sup> €**  
+ IVA

**DCF850NT-XJ**  
AVVITATORE IMPULSI 1/4"  
206MM

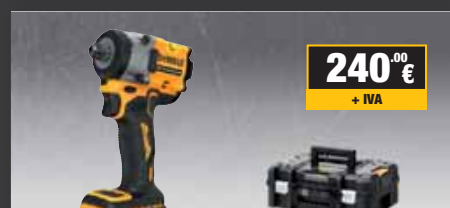

**240<sup>00</sup> €**  
+ IVA

**DCF922NT-XJ**  
AVVITATORE IMPULSI 1/2"  
406MM

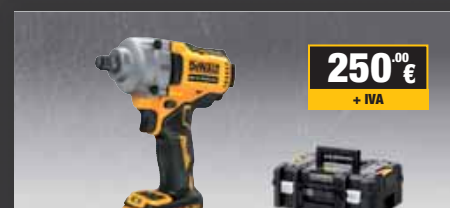

**250<sup>00</sup> €**  
+ IVA

**DCF891NT-XJ**  
AVVITATORE AD IMPULSI 1/2"  
812NM

\* Elettroutensile fornito senza valigetta TSTAK

# SCEGLI LA SOLUZIONE

**319<sup>00</sup> €**  
+ IVA

**DCF900NT-XJ**  
AVVITATORE AD IMPULSI 1/2"  
1355NM

**325<sup>00</sup> €**  
+ IVA

**DCF897NT-XJ**  
AVVITATORE AD IMPULSI 3/4"  
ALTA POTENZA 950NM

**199<sup>00</sup> €**  
+ IVA

**DCF512N-XJ**  
CRICCHETTO BRUSHLESS 1/2" \*

**219<sup>00</sup> €**  
+ IVA

**DCH172NT-XJ**  
TASSELLATORE SDS-PLUS 1.4J

**319<sup>00</sup> €**  
+ IVA

**DCH273NT-XJ**  
TASSELLATORE SDS-PLUS 2.1J

**215<sup>00</sup> €**  
+ IVA

**DCF620NT-XJ**  
AVVITATORE PER CARTONGESSO

**216<sup>00</sup> €**  
+ IVA

**DCS356NT-XJ**  
UTENSILE MULTIFUNZIONE

**209<sup>00</sup> €**  
+ IVA

**DCW210NT-XJ**  
LEVIGATRICE ROTO-ORBITALE  
Ø 125MM

**209<sup>00</sup> €**  
+ IVA

**DCW200NT-XJ**  
LEVIGATRICE ORBITALE  
1/4 DI FOGLIO

**270<sup>00</sup> €**  
+ IVA

**DCS334NT-XJ**  
SEGNETTO ALTERNATIVO

**265<sup>00</sup> €**  
+ IVA

**DCP580NT-XJ**  
PIALLETTO

**212<sup>00</sup> €**  
+ IVA

**DCS369NT-XJ**  
SEGA UNIVERSALE COMPATTA

**314<sup>00</sup> €**  
+ IVA

**DCGG571NK-XJ**  
PISTOLA INGRASSATRICE

**309<sup>00</sup> €**  
+ IVA

**DCE560N-XJ**  
PISTOLA PER SILICONE  
300-310 ML\*

**419<sup>00</sup> €**  
+ IVA

**DCE531N-XJ**  
VIBRATORE PER CEMENTO  
AGO 1.2MT TESTA 28.6MM

\* Elettroutensile fornito senza valigetta TSTAK



# 18V XR CHE FA PER TE



**520<sup>.00</sup> €**

+ IVA

RAGGIO VERDE

**DCLE34031N-XJ**  
TRACCIATORE LASER 3X 360°  
LUCE VERDE



**585<sup>.00</sup> €**

+ IVA

RAGGIO VERDE

**DCE089NG18-XJ**  
TRACCIATORE LASER 3X 360°  
LUCE VERDE



**265<sup>.00</sup> €**

+ IVA

**DCV584L-QW**  
ASPIRATORE SOLIDI E LIQUIDI  
7,5 LITRI\*



**127<sup>.00</sup> €**

+ IVA

**DCE512N-XJ**  
VENTILATORE\*



**280<sup>.00</sup> €**

+ IVA

**DCL074-XJ**  
FARO LED 360°\*



**157<sup>.00</sup> €**

+ IVA

**DCC018N-XJ**  
COMPRESSORE\*

## XR 18V NEL GARDEN

**18V**  
BRUSHLESS

**219<sup>.00</sup> €**

+ IVA



**DCM565N-XJ**  
ELETTOSEGA 30CM\*

**18V**  
BRUSHLESS

**179<sup>.00</sup> €**

+ IVA



**DCMHT563N-XJ**  
TAGLIASIEPI  
LUNGHEZZA LAMA 55CM\*

**18V**  
BRUSHLESS

**189<sup>.00</sup> €**

+ IVA



**DCM562PB-QW**  
SOFFIATORE ASSIALE  
VELOCITÀ VARIABILE\*

All'acquisto  
dello starter kit  
e di almeno  
2 corpi macchina

**A TUA SCELTA  
AVRAI IN DOTAZIONE**

**OPPURE**



**BATTERIA XR 18V 2AH**  
**DCB183-XJ**



**CARICABATTERIA XR 4A**  
**DCB1104-XJ**

\* Elettroutensile fornito senza valigetta TSTAK

## SEGHE A TAZZA BI-METAL

### FORATURA SU MATERIALI SPESSI CON UN SOLO PASSAGGIO

Il corpo della tazza più lungo permette di forare il legno, legno con chiodi, metallo e plastica e materiali duri 2 volte più velocemente.

**DURA FINO A 2 VOLTE\***  
FORMA DENTE BREVETTATA  
OTTIMIZZA RIMOZIONE DETRITI



**DESIGN PIÙ PROFONDO**  
per forare materiali spessi

**ESPULSIONE RAPIDA DEL MATERIALE**

### KIT

- DT90350-QZ** Kit Generico 13 pz - 16 / 19 / 25 / 32 / 38 / 44 / 48 / 51 / 64mm + 2 mandrini + 2 punte - **122,00€** + Iva
- DT90351-QZ** Kit Generico 11 pz - 16 / 20 / 25 / 32 / 40 / 51 / 64mm + 2 mandrini + 2 punte - **107,90€** + Iva
- DT90352-QZ** Kit Elettrocista 11 pz - 20 / 25 / 32 / 35 / 44 / 51 / 64mm + 2 mandrini + 2 punte - **107,90€** + Iva
- DT90353-QZ** Kit Generico 11 pz - 22 / 29 / 35 / 44 / 51 / 64 / 68mm + 2 mandrini + 2 punte - **115,00€** + Iva
- DT90354-QZ** Kit Elettrocista 11 pz - 16 / 20 / 25 / 32 / 35 / 51 / 64mm + 2 mandrini + 2 punte - **115,00€** + Iva
- DT90355-QZ** Kit Idraulico 11 pz - 19 / 22 / 29 / 38 / 44 / 51 / 57mm + 2 mandrini + 2 punte - **115,00€** + Iva
- DT90361-QZ** Kit Generico 13 pz - 20 / 22 / 25 / 32 / 35 / 38 / 44 / 51 / 64mm + 2 mandrini + 2 punte - **133,50€** + Iva

CODICE	DESCRIZIONE	€ s/IVA	CODICE	DESCRIZIONE	€ s/IVA	CODICE	DESCRIZIONE	€ s/IVA
DT90295-QZ	Ø 14mm	15,70 €	DT90313-QZ	Ø 41mm	17,20 €	DT90333-QZ	Ø 86mm	28,90 €
DT90297-QZ	Ø 17mm	15,70 €	DT90315-QZ	Ø 44mm	21,80 €	DT90338-QZ	Ø 102mm	35,10 €
DT90301-QZ	Ø 22mm	14,00 €	DT90319-QZ	Ø 52mm	20,20 €	DT90344-QZ	Ø 127mm	41,90 €
DT90303-QZ	Ø 25mm	14,40 €	DT90322-QZ	Ø 57mm	21,80 €	DT90346-QZ	Ø 152mm	50,00 €
DT90309-QZ	Ø 35mm	17,90 €	DT90324-QZ	Ø 64mm	20,60 €	DT8266-QZ	Ø 177mm	51,40 €
DT90311-QZ	Ø 38mm	17,10 €	DT90327-QZ	Ø 68mm	25,00 €	DT8267-QZ	Ø 210mm	51,80 €

### DESIGN VERSATILE

i denti in Carburo di Tungsteno sono ottimizzati per tagliare una varietà di materiali tra cui legno con chiodi, blocchi di cemento, fibrocemento e mattoni



### DURATA INCREDIBILE

I riporti in carburo di tungsteno ad alte prestazioni sono brasati al tagliente, questo consente di strappare i chiodi prevenendo la perdita dei denti



**6x PIÙ VELOCE**  
di una bi-metallica



## SEGHE A TAZZA MULTIMATERIALE AL CARBURO DI TUNGSTENO

### FORATURA SU MATERIALI SPESSI CON UN SOLO PASSAGGIO

Il corpo della tazza è più lungo e permette di forare il legno, legno con chiodi, plastica, metallo, mattoni, cartongesso, ceramica, piastrelle, poroton, acciaio strutturale e materiali duri 2 volte più velocemente. 60 mm di capacità di perforazione.

CODICE	DESCRIZIONE	€ s/IVA	CODICE	DESCRIZIONE	€ s/IVA	CODICE	DESCRIZIONE	€ s/IVA
DT90400-QZ	Ø 19mm	16,00 €	DT90410-QZ	Ø 44mm	18,40 €	DT90418-QZ	Ø 76mm	30,10 €
DT90402-QZ	Ø 22mm	16,00 €	DT90411-QZ	Ø 51mm	20,80 €	DT90420-QZ	Ø 86mm	33,40 €
DT90404-QZ	Ø 30mm	18,40 €	DT90412-QZ	Ø 57mm	25,20 €	DT90421-QZ	Ø 92mm	35,10 €
DT90406-QZ	Ø 35mm	20,60 €	DT90414-QZ	Ø 64mm	23,70 €	DT90423-QZ	Ø 102mm	40,30 €
DT90408-QZ	Ø 40mm	19,80 €	DT90417-QZ	Ø 70mm	29,10 €	DT90426-QZ	Ø 127mm	48,20 €

# PUNTE ATTACCO 1/4" BLACK&GOLD PER AVVITATORI AD IMPULSI

NOVITÀ

Angolo punta di 135° anche sui diametri piccoli per ridurre lo slittamento e aumentare la precisione del foro. La geometria della punta aumenta la velocità di foratura. Costruita in un unico blocco con nucleo rastremato, estrema robustezza e resistenza alle coppie degli avvitatori a impulsi. Utilizzo specifico su metallo, alluminio e plastica.



**Punta 135° antislittamento**  
Il design della punta a 135° aiuta a ridurre lo slittamento



**FINITURA** Nero e Dorata  
Aiuta a prevenire la ruggine



**Durata / Robustezza**  
Design a nucleo conico, estrema durata e resistenza alla rottura



**IMPACT READY®**  
Attacco esagonale 1/4" progettato per resistere alla coppia degli avvitatori ad impulsi e compatibile con la maggior parte dei trapani elettrici

CODICE	Ø x L TOT x L UTILE	€ s/IVA
DT20600-QZ	2 x 55 x 15 mm	2,00 €
DT20601-QZ	2.5 x 60 x 20 mm	2,15 €
DT20602-QZ	3 x 72 x 34 mm	2,64 €
DT20603-QZ	3.5 x 76 x 38 mm	2,80 €
DT20604-QZ	4 x 80 x 45 mm	3,08 €
DT20605-QZ	4.5 x 86 x 48 mm	3,40 €
DT20606-QZ	5 x 95 x 56 mm	4,04 €
DT20607-QZ	5.5 x 98 x 59 mm	4,36 €
DT20608-QZ	6 x 102 x 63 mm	4,60 €
DT20609-QZ	6.5 x 105 x 67 mm	4,68 €

CODICE	Ø x L TOT x L UTILE	€ s/IVA
DT20610-QZ	7 x 111 x 73 mm	4,84 €
DT20611-QZ	7.5 x 114 x 76 mm	5,24 €
DT20612-QZ	8 x 117 x 79 mm	5,48 €
DT20613-QZ	8.5 x 120 x 82 mm	5,67 €
DT20614-QZ	9 x 127 x 89 mm	6,31 €
DT20615-QZ	9.5 x 130 x 92 mm	7,19 €
DT20616-QZ	10 x 138 x 100 mm	7,92 €
DT20617-QZ	11 x 145 x 107 mm	8,88 €
DT20618-QZ	12 x 145 x 107 mm	10,08 €
DT20605-QZ	13 x 145 x 107 mm	11,20 €

**DT20620-QZ SET 10 PUNTE IMPACT BLACK&GOLD IN CASSETTA:  
3, 3.5, 4, 4.5, 5 X2, 6 X2, 8, 10MM**



NOVITÀ

## PUNTE ELICOIDALI PER FORARE METALLO, LEGNO, PLASTICA



**NUOVO DISEGNO DELLA PUNTA**  
Forature più veloci



**NUOVA FINITURA** Nero e Dorata



**NUCLEO CENTRALE RINFORZATO** aumenta la resistenza alla rottura



**CODOLO TRIANGOLARE**  
Alta tenuta evita slittamenti nel mandrino

## PUNTE COBALTO EXTREME

Per prestazioni eccezionali in foratura sull'acciaio INOX e materiali non ferrosi. Resistenza garantita fino a 1100 N/mm<sup>2</sup>. Adatto su lamiere dove è richiesta precisione e su tubi senza alcun problema.

### NUCLEO CENTRALE IRROBUSTITO

Spessore nucleo centrato maggiore verso il mandrino, migliora resistenza alla rottura, in particolare nell'uso a mano libera

**BULINO "NO-WALK"** permette una facile e precisa penetrazione di tutte le superfici.



**CODOLO TRIANGOLARE**  
Migliore presa nel mandrino

CODICE	DESCRIZIONE	€ s/IVA
DT20510-QZ	1 x 34 x 12 mm	1,50 €
DT20511-QZ	1.5 x 40 x 18 mm	1,60 €
DT20514-QZ	3 x 61 x 33 mm	1,50 €
DT20517-QZ	4 x 75 x 43 mm	1,70 €
DT20520-QZ	5 x 86 x 52 mm	2,30 €
DT20522-QZ	6 x 93 x 57 mm	2,60 €

CODICE	DESCRIZIONE	€ s/IVA
DT20523-QZ	6.5 x 101 x 63 mm	3,20 €
DT20524-QZ	7 x 109 x 69 mm	3,60 €
DT20525-QZ	7.5 x 109 x 69 mm	3,90 €
DT20526-QZ	8 x 117 x 75 mm	4,30 €
DT20530-QZ	10 x 133 x 87 mm	6,30 €
DT20536-QZ	13 x 151 x 101 mm	9,90 €

CODICE	Ø	€ s/IVA
DT4902-QZ	2x3 mm	4,70 €
DT4904-QZ	2x4 mm	4,70 €
DT4906-QZ	5 mm	5,80 €
DT4908-QZ	6 mm	5,80 €
DT4912-QZ	8 mm	8,20 €



COMPATIBILE CON BATTERIE  
**XR FLEX VOLT**

**FUNZIONAMENTO A 36V  
2 BATTERIE 18V  
IN CONTEMPORANEA**

**6 ALTEZZE DI TAGLIO**  
25, 35, 45, 60, 75, 85 mm  
Sistema di regolazione  
a due leve



**IMPUGNATURA  
ERGONOMICA**  
Sagomata per  
adattarsi alla presa.  
Ottimo controllo e  
ottimo comfort per  
uso prolungato

**DOPPIA  
MANIGLIA DI  
AVVIAMENTO**

**FUNZIONE MULCHING**  
raccolta erba nel cesto  
(capacità 55 lt)

**TELAIO IN METALLO  
DA 54CM**  
robusto e durevole per  
una migliore qualità  
di taglio

**899.<sup>00</sup> €**  
+ IVA

**IN DOTAZIONE:**  
2 batterie 18V/54V 9Ah  
+ 1 caricabatterie  
DCB118



## DCMWSP564N-IT RASAERBA **SEMOVENTE** A BATTERIA

- Maniglia ergonomica
- Doppia maniglia di avviamento
- **SEMOVENTE** per utilizzo prolungato senza fatica
- Funzione mulching
- Scocca in metallo da 54cm
- 6 altezze di taglio
- Ampiezza di taglio 53cm
- Area di taglio:  
18V 2x5.0Ah fino a 600mq  
54V 2x6.0Ah fino a 900mq  
54V 2x9.0Ah fino a 1200mq
- **FUNZIONAMENTO A 36V 2 BATTERIE 18V  
IN CONTEMPORANEA**



**299.<sup>00</sup> €**  
+ IVA



**DCM565P1-QW**  
**ELETTOSEGA BARRA 30CM**  
**1 BATTERIA XR 18V 5.0AH**



**299.<sup>00</sup> €**  
+ IVA



**DCMPS567P1-QW**  
**POTATORE AD ASTA**  
**1 BATTERIA XR 18V 5.0AH**



**229.<sup>00</sup> €**  
+ IVA



**DCMBL562P1-QW**  
**SOFFIATORE ASSIALE**  
**1 BATTERIA XR 18V 5.0AH**

**DCMHT563P1-QW**  
**TAGLIASIEPI**  
**LAMA 55CM**  
**1 BATTERIA XR**  
**18V 5.0AH**



**229.<sup>00</sup> €**  
+ IVA



**DCMPH566P1-QW**  
**TAGLIASIEPI**  
**TELESCOPICO**  
**1 BATTERIA XR**  
**18V 5.0AH**



**339.<sup>00</sup> €**  
+ IVA



**DCMPP568P1-QW**  
**CESOIA DA**  
**POTATURA**  
**1 BATTERIA XR**  
**18V 5.0AH**



**239.<sup>00</sup> €**  
+ IVA



**DCMST561P1-QW**  
**TAGLIABORDI**  
**36CM**  
**1 BATTERIA XR**  
**18V 5.0AH**



**349.<sup>00</sup> €**  
+ IVA



# GIARDINO

54V XR FLEXVOLT

**AUTONOMIA:**  
FINO A 115 TAGLI PER CARICA\*

\*su tronchi 150x150mm  
con batteria da 15Ah



DCMCS575X1-QW

**789.<sup>00</sup> €**

+ IVA

VALIGETTA PER IL  
TRASPORTO ROBUSTA.  
PROTEGGE LA SEGA  
E LA BARRA

## ELETTOSEGA 54V FLEXVOLT CON BARRA DA 50CM

- Velocità catena 13,5 m/s
- Peso 5.5Kg
- Tensionamento variabile della catena
- Potenza Max 3000W
- Coppia Max 6.4Nm

Batteria FlexVolt DCB547 9.0Ah

54V XR FLEXVOLT

**AUTONOMIA:**  
FINO A 115 TAGLI PER CARICA\*

\*su tronchi 150x150mm  
con batteria da 15Ah



DCMCS574X1-QW

**749.<sup>00</sup> €**

+ IVA

VALIGETTA PER IL  
TRASPORTO ROBUSTA.  
PROTEGGE LA SEGA  
E LA BARRA

## ELETTOSEGA 54V FLEXVOLT CON BARRA DA 45CM

- Velocità catena 13,5 m/s
- Peso 5.0Kg
- Tensionamento variabile della catena
- Potenza Max 2000W
- Coppia Max 5.0Nm

Batteria FlexVolt DCB547 9.0Ah

54V XR FLEXVOLT



DCM575X1-QW

**539.<sup>00</sup> €**

+ IVA

## ELETTOSEGA 54V FLEXVOLT CON BARRA DA 40CM

- Velocità catena 15 m/s
- Peso 4.4Kg
- Tensionamento variabile della catena
- Potenza Max 1700W
- Coppia Max 5.0Nm

Batteria FlexVolt DCB547 9.0Ah

## SOFFIATORE ASSIALE BRUSHLESS XR FLEXVOLT

Batteria FlexVolt  
DCB547 9.0Ah

54V XR FLEXVOLT



DCMBA572X1-QW

**469.<sup>00</sup> €**

+ IVA

## SOFFIATORE BRUSHLESS XR FLEXVOLT

Batteria FlexVolt  
DCB547 9.0Ah

54V XR FLEXVOLT



DCM572X1-QW

**459.<sup>00</sup> €**

+ IVA

## DCMAS5713X1-QW MULTIFUNZIONE GARDEN 54V XR

- Impugnatura ergonomica
- Velocità variabile
- Alta / bassa velocità 4650-5800
- Compatto da riporre,  
facile da trasportare
- Rocchetto tecnologia  
Quick-Load™
- Peso 6.5Kg

**589.<sup>00</sup> €**

+ IVA

IN DOTAZIONE:  
Attacco decespugliatore,  
Batteria 54V 9.0Ah,  
Caricabatterie, borsa

## LEGGERO E COMPATTO 6,5 KG

54V XR FLEXVOLT

MECCANISMO  
DI SGANCIO RAPIDO  
compatto da riporre  
e facile da trasportare



AMPIEZZA DI TAGLIO  
38cm

DOPPIO FILO DI NYLON DeWALT 2.4mm  
per un taglio sempre perfetto

ATTACCO  
POTATORE

DCMASPS5N-XJ

**129.<sup>00</sup> €**

+ IVA

ATTACCO  
DECESPUGLIATORE

DCMASBC1N-XJ

**109.<sup>00</sup> €**

+ IVA

ATTACCO  
TAGLIASIEPI

DCMASPH6N-XJ

**159.<sup>00</sup> €**

+ IVA

ATTACCO  
TAGLIABORDI

DCMASST1N-XJ

**99.<sup>00</sup> €**

+ IVA

# LEGGEREZZA SENZA LIMITI

ACQUISTA UN ELETTROUTENSILE 12V  
DI QUESTA PAGINA ED  
AVRAI LA 3<sup>a</sup> BATTERIA  
XR 12V DA 2AH

**DCB127-XJ \***



**12V XR**  
BRUSHLESS

**DCD701D2-QW**  
TRAPANO AVVITATORE  
12V XR 2AH



**205<sup>00</sup> €**  
+ IVA

**MANDRINO  
IN METALLO!**



**DCD706D2-QW**  
TRAPANO AVVITATORE  
A PERCUSSIONE  
12V XR 2AH



**230<sup>00</sup> €**  
+ IVA

**290<sup>00</sup> €**  
+ IVA



**DCD703L2T-QW TRAPANO  
AVVITATORE MULTITESTA 1/4"**  
**BRUSHLESS 12V XR 3AH**

- Coppia 57.5Nm
- Velocità a vuoto 0-425/0-1.500 giri/min
- Peso 1.1Kg
- 15 punti di frizione
- Max. Ø legno/metallo: 20/10 mm

DOTAZIONE: 4 teste intercambiabili, gancio per cintura, 2 batterie XR 12V 3Ah, caricabatterie, valigetta TSTAK

**DCH072L2-QW**  
TASSELLATORE SDS-PLUS  
BRUSHLESS 14MM 12V XR 3AH

- 4280 percussioni al minuto
- 2 modalità (foratura con percussione, foratura)
- Potenza del colpo (EPTA 05/2009) 1.1J
- Max foratura [Cemento] 14mm
- Peso 1.9Kg

DOTAZIONE: 2 batterie XR 12V 3Ah, gancio per cintura, caricabatterie, valigetta TSTAK

**359<sup>00</sup> €**  
+ IVA



**287<sup>00</sup> €**  
+ IVA



**DCS353D2-QW**  
UTENSILE MULTIFUNZIONE  
BRUSHLESS 12V XR 2AH

- Angolo oscillazione destra/sinistra 1.6°
- Velocità variabile
- Orbite/min 0-18000
- Cambio accessori senza utensili
- Luce LED
- Peso (solo corpo macchina) 0.9Kg

DOTAZIONE: Set accessori per tagli e levigatura, adattatore universale, adattatore per aspirazione, 2 batterie XR 12V 2Ah, caricabatterie, valigetta TSTAK

\* La 3a batteria è in dotazione solo sui seguenti codici: DCD701D2-QW, DCD706D2-QW, DCD703L2T-QW, DCH072L2-QW e DCS353D2-QW



DCF901P2-QW

345.<sup>00</sup> €

+ IVA



DCF903P2-QW

345.<sup>00</sup> €

+ IVA



**DCF901P2-QW / DCF903P2-QW  
AVVITATORE AD IMPULSI  
12V XR 5AH**

- Attacco 1/2" (DCF901) - 3/8" (DCF903)
- Coppia sostenuta 340Nm
- Coppia di picco 500Nm
- Max Ø bullone M16

DOTAZIONE: 2 batterie 12V XR 5Ah, caricabatteria, valigetta TSTAK

**PRECISION  
DRIVE**

237.<sup>00</sup> €

+ IVA



**DCF801D2-QW  
AVVITATORE AD IMPULSI 1/4"  
12V XR 2AH - 163 NM**

**PRECISION  
WRENCH**

237.<sup>00</sup> €

+ IVA



**DCF902D2-QW  
AVVITATORE AD IMPULSI 3/8"  
12V XR 2AH - 163 NM**

215.<sup>00</sup> €

+ IVA



**DCF601D2-QW  
AVVITATORE 1/4"  
12V XR 2AH - 8 NM**

CON BATTERIA

**3AH**



359.<sup>00</sup> €

+ IVA



**DCK2110L2T-QW KIT 12V XR 3AH**

**DCD701 TRAPANO AVVITATORE**

- Coppia massima 57Nm
- Velocità 0-425 / 0-1500 gir/min

**DCF801 AVVITATORE AD IMPULSI 1/4"**

- Coppia massima 163Nm
- 3 velocità 0-1000/1500/2600 giri/min
- Portainseriti a sgancio rapido da 1/4"

DOTAZIONE: 2 batterie 12V XR 3Ah, Caricabatterie, Valigetta TSTAK

**DCS512P2-QW SEGA CIRCOLARE  
BRUSHLESS 140MM 12V XR 5AH**

- ø lama/foto 140/20mm
- Velocità lama 3600 Giri/min
- Max inclinazione testa 50°
- Max profondità taglio 90/45° 47/33mm
- Freno elettronico
- Luce Led

DOTAZIONE: lama tct 24 denti, 2 batterie 12V XR 5Ah, caricabatterie, guida parallela, chiave di servizio, adattatore aspirazione AirLock, TSTAK

400.<sup>00</sup> €

+ IVA





## I VANTAGGI DELLA STRUMENTAZIONE LASER DEWALT



UNA GAMMA COMPLETA PER SVOLGERE IL LAVORO IN MENO TEMPO, AUMENTANDO LA PRODUTTIVITÀ.



NUOVA TECNOLOGIA CON DOPPIA COMPATIBILITÀ DELLE BATTERIE 12V/18V XR.



CENTRO ASSISTENZA INTERNO DEDICATO, DOTATO DELLE MIGLIORI TECNOLOGIE PER RIPARAZIONI, TARATURE E CERTIFICAZIONI.

### DCLE34021D1-QW TRACCIATORE LASER A CROCE 90°

- DIODO VERDE (CL 2 510-530nm) Luce pulsante
- Interruttore con blocco del pendolo
- Autolivellamento +/- 4°
- Precisione +/- 3mm / 10 mt
- Grado di protezione IP54
- Visibilità max 55mt (100mt con ricevitore)
- Memorizza l'ultima selezione dei raggi
- Base pivotante con magneti
- Attacco treppiede ¼" e 5/8" su supporto a parete

#### DOTAZIONE:

1 batteria 18V XR 2Ah, caricabatteria, supporto da parete, target verde, valigetta

**315<sup>.00</sup> €**  
+ IVA

NOVITÀ





NOVITÀ

### KIT TRAPANO + TRACCIATORE 3 LINEE 18V XR DCK2095D2T-QW

- **DCD805 TRAPANO A PERCUSSIONE**  
Potenza 90Nm  
Velocità 0-650/2000 giri/min  
Percussioni 0-34000 min
  - **DCLE34031 Tracciatore a 3 linee 360°**  
Diodo verde  
Autolivellamento +/- 4mm  
Precisione +/- 3 mm/10m  
Visibilità max 40m (100m con ricevitore)
- DOTAZIONE:**  
2 batterie 18V XR 2Ah, caricabatteria, supporto da parete, target verde, valigetta

699<sup>.00</sup> €  
+ IVA

18V XR



605<sup>.00</sup> €  
+ IVA

RAGGIO  
VERDE

18V XR



### DCLE34031D1-QW TRACCIATORE A 3 LINEE 360° (1 ORIZZONTALE + 2 VERTICALI A 90°)

- DIODO VERDE (CL 2 510-530nm) Luce pulsante
- Autolivellamento +/- 4°
- Precisione +/- 3mm/10m
- Visibilità max 40m (100m con ricevitore)
- Effetto memoria dell'ultima posizione del raggio
- Base magnetica
- Attacco treppiede 1/4" + 5/8" su supp. a parete

**DOTAZIONE:**  
1 Batteria 18V XR 2Ah, caricabatteria, supporto da parete, target verde, valigetta

### DCE089D1G18-QW TRACCIATORE A 3 LINEE 360°

- Autolivellamento +/- 4°
- Precisione +/- 3mm/10m
- Visibilità max 30 Mt (50 Mt con ricevitore)
- Base magnetica e pivottante
- Attacco treppiede 1/4" + 5/8"

**DOTAZIONE:** 1 Batteria 18V XR 2Ah, caricabatteria, supporto da parete, Target verde, valigetta TSTAK

660<sup>.00</sup> €  
+ IVA

RAGGIO  
VERDE

DOPPIA COMPATIBILITÀ  
12V / 18V



DCE089D1G-QW

605<sup>.00</sup> €  
+ IVA

RAGGIO VERDE

Visibilità max 30 Mt  
(50 Mt con ricevitore)

DCE089D1R-QW

470<sup>.00</sup> €  
+ IVA

RAGGIO ROSSO

Visibilità max 15 Mt  
(50 Mt con ricevitore)



12V XR

### TRACCIATORE A TRE LINEE 360° (2 VERTICALI A SQUADRO + 1 ORIZZONTALE)

- Autolivellamento +/- 4°
- Precisione +/- 3mm/10m
- Base magnetica e pivottante
- Attacco treppiede 1/4" + 5/8"

**DOTAZIONE:** 1 batteria 12V XR 2.0Ah, caricabatterie, supporto da parete, target, occhiali, valigetta TSTAK.

# TRACCIATORI LASER

**12V XR**

**445.<sup>00</sup> €**  
+ IVA

**RAGGIO VERDE**  
Visibilità max 45 Mt punti / 20Mt linee (50 Mt con ricevitore)

## DCE0822D1G-QW TRACCIATORE A CROCE 90° + 2 PUNTI PIOMBO

- Autolivellamento +/- 4°
- Precisione +/- 3mm/10m
- Blocco pendolo
- Base magnetica e pivottante
- Attacco treppiede 1/4" + 5/8"

DOTAZIONE: 1 batteria 12V XR 2Ah, caricabatterie, supporto da parete, target, occhiali, valigetta TSTAK

**12V XR**

**445.<sup>00</sup> €**  
+ IVA

**RAGGIO VERDE**  
Visibilità max 45 Mt punti / 20Mt linee (50 Mt con ricevitore)

## DCE0825D1G-QW TRACCIATORE A CROCE 90° + 5 PUNTI (2 PIOMBO + 1 FRONTALE + 2 LATERALI A 90°)

- Autolivellamento +/- 4°
- Precisione +/- 3mm/10m
- Blocco pendolo
- Base magnetica e pivottante
- Attacco treppiede 1/4" + 5/8"

DOTAZIONE: 1 batteria 12V XR 2Ah, caricabatterie, supporto da parete, target, occhiali, valigetta TSTAK

**RAGGIO ROSSO**

**DW088K-XJ**  
**172.<sup>00</sup> €**  
+ IVA

**DW088KTRI-XJ**  
**249.<sup>00</sup> €**  
+ IVA

IN DOTAZIONE CAVALLETTA DE0881

## TRACCIATORE A CROCE 90° RAGGIO ROSSO

- Autolivellamento +/- 4°
- Precisione +/- 3mm/10m
- Visibilità max 15 Mt (50 Mt con ricevitore)
- Base magnetica e pivottante
- Attacco treppiede 1/4"

DOTAZIONE: 3 batterie AA, supporto da parete, valigetta

**239.<sup>00</sup> €**  
+ IVA

**RAGGIO ROSSO**

## DW0822-XJ TRACCIATORE A CROCE 90° + 2 PUNTI PIOMBO

- Autolivellamento +/- 4°
- Precisione +/- 3mm/10m
- Visibilità max 30 Mt (50 Mt con ricevitore)

DOTAZIONE: 3 batterie AA, supporto magnetico da parete, valigetta

**219.<sup>00</sup> €**  
+ IVA

**RAGGIO VERDE**

## DW088CG-XJ TRACCIATORE A CROCE 90° LUCE VERDE

- Autolivellamento +/- 4°
- Precisione +/- 3mm/10m
- Visibilità max 30 Mt (50 Mt con ricevitore)

DOTAZIONE: 3 batterie AA, supporto magnetico da parete, valigetta

**355.<sup>00</sup> €**  
+ IVA

**RAGGIO ROSSO**

## DW089K-XJ TRACCIATORE 3 LINEE LUCE ROSSA

- Autolivellamento +/- 4°
- Precisione +/- 3mm/10m
- Visibilità max 15 Mt (50 Mt con ricevitore)

DOTAZIONE: 4 batterie AA, supporto magnetico da parete, valigetta

**DCE080D1GS-QW**  
**1.830.<sup>00</sup> €**  
+ IVA

**RAGGIO VERDE**  
Visibilità max 30 Mt (300 Mt con ricevitore)

**DCE080D1RS-QW**  
**1.540.<sup>00</sup> €**  
+ IVA

**RAGGIO ROSSO**  
Visibilità max 30 Mt (300 Mt con ricevitore)

IN DOTAZIONE CON I LASER ROTATIVI UN CAVALLETTA DE0736-XJ

## LASER ROTATIVO AUTOLIVELLANTE + PIOMBO BLUETOOTH

- Autolivellamento +/- 4°
- Precisione +/- 1.5mm/30m
- Connessione Bluetooth per accensione e controllo strumento
- Doppia pendenza +/- 10% regolabile con app Toolconnect, connessa a Bluetooth
- Attacco treppiede 5/8"

DOTAZIONE: 1 batteria 18V XR 2Ah, caricabatterie, ricevitore, supporto da parete, telecomando, scheda bersaglio, occhiali, valigetta TSTAK.

**DCE079D1G-QW**  
**1.450.<sup>00</sup> €**  
+ IVA

**RAGGIO VERDE**  
Visibilità max 38 Mt (300 Mt con ricevitore)

**DCE079D1R-QW**  
**1.220.<sup>00</sup> €**  
+ IVA

**RAGGIO ROSSO**  
Visibilità max 30 Mt (300 Mt con ricevitore)

## LASER ROTATIVO AUTOLIVELLANTE + PIOMBO

- Autolivellamento +/- 4°
- Precisione +/- 1.5mm/30m
- Doppia pendenza manuale fino a +/-10%
- Attacco treppiede 5/8"

DOTAZIONE: 1 batteria 18V XR 2Ah, caricabatterie, ricevitore, supporto da parete, telecomando, scheda bersaglio, occhiali, valigetta TSTAK.

# MISURATORI LASER

## DW055PL-XJ 16 METRI

- Misura da 0,165 a 16 metri
- Precisione tipica +/- 6mm/10m
- 620/680Nm >1Nw
- Funzioni: misurazione lineare e continua
- Batteria al litio ricaricabile cavo USB



**38<sup>00</sup> €**  
+ IVA

## DWHT77100-XJ 30 METRI

- Precisione +/- 3 mm/10m
- Calcolo area, volume e pitagora
- Corpo sovrastampato in gomma per una miglior presa
- Compatto e leggero
- Alimentazione 2 batterie tipo AAA (in dotazione)



**71<sup>00</sup> €**  
+ IVA

## DW03050-XJ 50 METRI

- Misura da 0,05 a 50 metri
- Precisione tipica 1,5mm
- Squadretta pieghevole, inclinometro

FUNZIONI: misura lineare, continua, addizioni e sottrazioni, volumi, 2 Pitagora, 5 memorie.

DOTAZIONE: 2 batterie AAA, Fodero.



**151<sup>00</sup> €**  
+ IVA

**DISPLAY  
RETROILLUMINATO**



## DW03101-XJ 100 METRI

- Misura da 0,05 a 100 metri
- Precisione tipica 1,5mm
- Squadretta ripieghevole

FUNZIONI: misura lineare, continua, addizioni e sottrazioni, volumi, 3 Pitagora, inclinometro, tracciamento, display a 3 linee, 20 memorie.

DOTAZIONE: 2 batterie AAA, Fodero.



**237<sup>00</sup> €**  
+ IVA

**DISPLAY  
RETROILLUMINATO**



# ACCESSORI LASER

## RICEVITORI PER LASER A LINEA

- Portata 50 metri
- Due livelli di precisione
- Allarme sonoro a 3 livelli

**RAGGIO VERDE**

DE08926-XJ

**125<sup>00</sup> €**  
+ IVA



**RAGGIO ROSSO**

DE0892-XJ

**125<sup>00</sup> €**  
+ IVA

## DE0733-XJ TREPIEDE TELESCOPICO

- Altezza da cm 120 a 240
- Regolazione altezza con manovella

**100<sup>00</sup> €**  
+ IVA



## DE0735-XJ TREPIEDE TELESCOPICO

- In alluminio
- Altezza max 3 mt
- Regolazione di altezza con manovella
- Attacco 5/8"

**205<sup>00</sup> €**  
+ IVA



## DE0734-XJ ASTA GRADUATA TELESCOPICA

- Graduazione topografica e mm
- Altezza max 4 metri

**70<sup>00</sup> €**  
+ IVA



## DE0737-XJ ASTA LASER GRADUATA CON BOLLA

- Lunghezza massima m.2,40

**82<sup>00</sup> €**  
+ IVA



## DE0882-XJ ASTA CON ATTACCO 1/4"

- Altezza massima m.3,40

**113<sup>00</sup> €**  
+ IVA



# GAMMA TASSELLATORI



**TASSELLATORE  
IN LINEA 26MM  
DOPPIO  
MANDRINO  
D25134K-QS**



**189.<sup>00</sup> €**

+ IVA

**TASSELLATORE  
IN LINEA 28MM  
DOPPIO  
MANDRINO  
D25144K-QS**



**245.<sup>00</sup> €**

+ IVA

**TASSELLATORE  
A "L" 30MM  
D25333K-QS**



VIBRATION

DUST



**335.<sup>00</sup> €**

+ IVA

**TASSELLATORE  
A "L" 30MM  
DOPPIO  
MANDRINO  
D25334K-QS**



VIBRATION

DUST



**375.<sup>00</sup> €**

+ IVA

**TASSELLATORE  
A "L" 32MM  
D25413K-QS**



VIBRATION



**530.<sup>00</sup> €**

+ IVA

# PUNTE E SCALPELLI SDS MAX E SDS PLUS



Made in Germany

## EXTREME PUNTE SDS-MAX AL CARBURO A TESTA PIENA



**SPIRALE A 4 CANALI**  
Rapida rimozione del materiale

**MARCHIO DI USURA (WEAR MARK)**  
Indica l'accuratezza del ø del foro. Accurata installazione di ancoraggi meccanici.



### TAGLIENTI IN CARBURO

Singolo pezzo di carburo con 4 taglienti, progettati per ridurre al minimo le vibrazioni.

### IRON BLAST TECHNOLOGY™

Riduce lo stress sulla testa ed incrementa la robustezza lungo tutto il corpo.

CODICE	DIAMETRO	LUNGH. TOT.	Prezzo s/IVA
DT60810-QZ	16 mm	540 mm	60,00 €
DT60812-QZ	18 mm	540 mm	64,30 €
DT60817-QZ	20 mm	540 mm	64,30 €
DT60820-QZ	22 mm	540 mm	66,50 €
DT60823-QZ	24 mm	540 mm	71,90 €
DT60825-QZ	25 mm	540 mm	71,90 €
DT60830-QZ	28 mm	570 mm	85,00 €
DT60833-QZ	30 mm	570 mm	90,50 €
DT60835-QZ	32 mm	570 mm	97,00 €
DT60838-QZ	35 mm	570 mm	111,20 €

## EXTREME PUNTE SDS-MAX AL CARBURO

**SPIRALE E 4 CANALI**  
Rapida rimozione del materiale

**NUCLEO RINFORZATO**  
Ottima resistenza all'impatto ed alla rottura. Efficiente trasmissione dell'energia alla testa della punta.



### TRASMISSIONE OTTIMALE DEL COLPO

Il nucleo irrobustito permette una più efficiente trasmissione dell'energia ai taglienti della testa. Speciale metodo di saldatura.

**PUNTA IN CARBURO** La solida testa a 2 taglienti garantisce una veloce ed efficiente velocità di foratura. Testa in carburo e il corpo sono brasati insieme per aumentare robustezza e durata.

CODICE	DIAMETRO	LUNGH. TOT.	Prezzo s/IVA
DT9410-QZ	16 mm	540 mm	56,70 €
DT9412-QZ	18 mm	540 mm	58,90 €
DT9417-QZ	20 mm	540 mm	58,90 €
DT9420-QZ	22 mm	540 mm	60,00 €
DT9423-QZ	24 mm	540 mm	68,70 €
DT9425-QZ	25 mm	540 mm	68,70 €
DT9430-QZ	28 mm	570 mm	79,60 €
DT9433-QZ	30 mm	570 mm	85,00 €
DT9435-QZ	32 mm	570 mm	91,60 €
DT9438-QZ	35 mm	570 mm	103,60 €

## XLR PUNTE SDS-PLUS

**VELOCITÀ** Spirale a 4 canali ottimizza lungo tutta l'elica la rimozione dei detriti per una rapida foratura e fori puliti.

**VIBRAZIONI RIDOTTE**  
Potenza del colpo redistribuita sulle 4 teste taglienti



**DURATA** Trattamento termico ottimizzato per la massima resistenza. Testa ed corpo indissolubilmente saldati con uno speciale metodo di saldatura.

**TESTA IN CARBURO** 4 taglienti al carburo evitano inceppamento nel fondino. Garantisce fori puliti ed elevata velocità di foratura.

CODICE	DIAMETRO	LUNGH. TOT.	Prezzo s/IVA
DT8908-QZ	5 mm	160 mm	5,80 €
DT8912-QZ	6 mm	110 mm	5,50 €
DT8913-QZ	6 mm	160 mm	5,70 €
DT8914-QZ	6 mm	210 mm	6,30 €
DT8923-QZ	8 mm	160 mm	6,90 €
DT8924-QZ	8 mm	210 mm	7,10 €
DT8925-QZ	8 mm	260 mm	8,30 €
DT8928-QZ	10 mm	160 mm	7,40 €
DT8929-QZ	10 mm	210 mm	8,50 €
DT8930-QZ	10 mm	260 mm	10,20 €
DT8935-QZ	12 mm	260 mm	12,00 €
DT8936-QZ	12 mm	310 mm	18,50 €
DT8940-QZ	14 mm	260 mm	16,40 €
DT8941-QZ	14 mm	310 mm	18,50 €

## PUNTE EXTREME 2 SDS-PLUS 2 TAGLIENTI

**SPIRALE A 2 CANALI**  
Accellera la rimozione del calcostrozzatura dalla punta, riducendo temperatura di lavoro e velocizzando la foratura.

**MARCHIO DI USURA (WEAR MARK)\***  
Indica l'accuratezza del ø del foro. Accurata installazione di ancoraggi meccanici.



**TOUGH CORE™**  
Il nucleo centrale afusolato conferisce forza e resistenza nei fori profondi, riduce la flessione tra la scanalatura e il gambo, prevenendo la frattura della punta.

CODICE	DIAMETRO	LUNGH. TOT.	Prezzo s/IVA
DT9505-QZ	5 mm	160 mm	3,60 €
DT9514-QZ	6 mm	110 mm	3,10 €
DT9515-QZ	6 mm	160 mm	3,40 €
DT9516-QZ	6 mm	210 mm	5,50 €
DT9530-QZ	8 mm	160 mm	4,70 €
DT9531-QZ	8 mm	210 mm	6,30 €
DT9532-QZ	8 mm	260 mm	7,20 €
DT9540-QZ	10 mm	160 mm	4,30 €
DT9541-QZ	10 mm	210 mm	5,30 €
DT9542-QZ	10 mm	260 mm	6,90 €
DT9552-QZ	12 mm	260 mm	5,60 €
DT9553-QZ	12 mm	310 mm	7,00 €
DT9567-QZ	14 mm	260 mm	8,30 €
DT9568-QZ	14 mm	310 mm	9,00 €

## SCALPELLI SDS-MAX

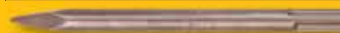

Geometria della punta ottimizzata per mantenere l'affilatura e la capacità produttiva. Acciaio appositamente temprato e trattamento termico controllato da microprocessore per garantire punte resistenti e di lunga durata. Testa in acciaio duro per resistere all'usura e demolire in velocità. Corpo in acciaio più morbido per resistere ai contraccolpi e ridurre al minimo le rotture.

CODICE	TIPO	MISURA	Prezzo s/IVA
DT6821-QZ	A Punta	400 mm	17,40 €
DT6823-QZ	Piatto	400x25 mm	17,40 €
DT6824-QZ	Spatola	360x50 mm	33,80 €
DT6825-QZ	Spatola	300x80 mm	34,90 €
DT6889-QZ	A Punta	400 mm	26,20 €
DT6812-QZ	Piatto	400x25 mm	26,20 €
DT6818-QZ	Spatola	360x50 mm	40,30 €

## SCALPELLI SDS-PLUS



CODICE	TIPO	MISURA	Prezzo s/IVA
DT6801-QZ	A Punta	250 mm	12,00 €
DT6802-QZ	Piatto	250x20 mm	12,00 €
DT6803-QZ	Spatola	250x40 mm	18,50 €
DT6806-QZ	Piastrelle	250x40 mm	24,00 €
DT6978-QZ	A Punta	250 mm	20,70 €
DT6979-QZ	Piatto	250x20 mm	20,70 €
DT6984-QZ	Spatola	250x40 mm	21,80 €

# SPECIALE MARTELLI A FILO



**VIBRATION**

**CONTROL**



## DEMO-PERFORATORI

**MARTELLLO  
DEMO-PERFORATORE  
10.5J  
D25614K-QS**

**660<sup>00</sup> €**  
+ IVA



**VIBRATION**

**CONTROL**



1350 W



7.8 kg



8.8 m/s<sup>2</sup>



45 mm



No



**VIBRATION**

**CONTROL**



**MARTELLLO  
DEMO-PERFORATORE  
13.3J  
D25733K-QS**

**840<sup>00</sup> €**  
+ IVA



1600 W



9.5 kg



9.3 m/s<sup>2</sup>



48 mm



No

**MARTELLLO  
DEMO-PERFORATORE  
19.4J  
D25773K-QS**

**899<sup>00</sup> €**  
+ IVA



**VIBRATION**

**CONTROL**



1700 W



10.5 kg



10.5 m/s<sup>2</sup>



52 mm



No



POTENZA



PESO



VIBRAZIONI



CAPACITÀ MAX  
DI FORATURA



DOPPIO  
MANDRINO



**VIBRATION**

## DEMOLITORI

**MARTELLINO  
DEMOLITORE  
7.1J  
D25810K-QS**

**435<sup>.00</sup> €**

+ IVA



**SDS max**



1050 W



5.6 kg



9.4 m/s<sup>2</sup>

**MARTELLINO  
DEMOLITORE  
10.5J  
D25832K-QS**

**600<sup>.00</sup> €**

+ IVA



**SDS max**



1250 W



7.4 kg



8.8 m/s<sup>2</sup>

**MARTELLINO  
DEMOLITORE  
13.3J  
D25872K-QS**

**720<sup>.00</sup> €**

+ IVA



**SDS max**



1600 W



8.8 kg



9.7 m/s<sup>2</sup>

**MARTELLINO  
DEMOLITORE  
19J  
D25902K-QS**

**850<sup>.00</sup> €**

+ IVA



**SDS max**



1550 W



10.5 kg



8.0 m/s<sup>2</sup>

**MARTELLINO  
DEMOLITORE  
24J  
D25951K-QS**

**1.045<sup>.00</sup> €**

+ IVA



**SDS max**



1600 W



13.3 kg



8.8 m/s<sup>2</sup>

**MARTELLINO  
DEMOLITORE  
35J  
EXA 30MM  
D25961K-QS**

**1.299<sup>.00</sup> €**

+ IVA



1600 W



16.9 kg



6.8 m/s<sup>2</sup>

**MARTELLINO  
DEMOLITORE  
62J  
EXA 28MM  
D25981K-QS  
CON CARRELLO**

**1.890<sup>.00</sup> €**

+ IVA



2100 W



31 kg



4.8 m/s<sup>2</sup>

# SPECIALE MARTELLI

## DEMOLITORI 54V



**MARTELLINO  
DEMOLITORE  
19.4J  
DCH892X2-QW**

POSSIBILITÀ  
DI ALLOGGIARE  
LE BATTERIE  
XR FLEXVOLT  
15AH  
(DCB549-XJ)

54V XR FLEXVOLT 15AH



**1.099<sup>.00</sup> €**  
+ IVA



54 V



8.9 kg



9.4 m/s<sup>2</sup>

**MARTELLINO  
DEMOLITORE  
10.5J  
DCH832X2-QW**

POSSIBILITÀ  
DI ALLOGGIARE  
LE BATTERIE  
XR FLEXVOLT  
15AH  
(DCB549-XJ)

54V XR FLEXVOLT 15AH



**949<sup>.00</sup> €**  
+ IVA



54 V



6.5 kg



8.7 m/s<sup>2</sup>

## DEMO-PERFORATORI 54V



**MARTELLINO  
DEMO-  
PERFORATORE  
6.1J  
DCH481X2-QW**



54V XR FLEXVOLT 9AH



**1.085<sup>.00</sup> €**  
+ IVA



54 V



6.7 kg



9.4 m/s<sup>2</sup>

**MARTELLINO  
DEMO-  
PERFORATORE  
10.5J  
DCH614X2-QW**



54V XR FLEXVOLT 9AH



**1.140<sup>.00</sup> €**  
+ IVA



54 V



8.3 kg



8.8 m/s<sup>2</sup>

**MARTELLINO  
DEMO-  
PERFORATORE  
SDS-MAX 13.3J  
DCH735X2-QW**

POSSIBILITÀ  
DI ALLOGGIARE  
LE BATTERIE  
XR FLEXVOLT  
15AH  
(DCB549-XJ)



54V XR FLEXVOLT 15AH



**1.240<sup>.00</sup> €**  
+ IVA



54 V



10 kg



9.0 m/s<sup>2</sup>

**MARTELLINO  
DEMO-  
PERFORATORE  
SDS-MAX 19.4J  
DCH775X2-QW**

POSSIBILITÀ  
DI ALLOGGIARE  
LE BATTERIE  
XR FLEXVOLT  
15AH  
(DCB549-XJ)



54V XR FLEXVOLT 15AH



**1.285<sup>.00</sup> €**  
+ IVA



54 V



10.9 kg



10.1 m/s<sup>2</sup>



POTENZA



PESO



VIBRAZIONI



CAPACITÀ MAX  
DI FORATURA



DOBPIO  
MANDRINO



# ASPIRAZIONE

**500<sup>00</sup> €**  
+ IVA

**PERFORM PROTECT**

**AIR LOCK**



## DWV901LT-QS ASPIRATORE A FILO SOLIDI/LIQUIDI 30LT CLASSE L 1400W

- Sistema a doppio filtro alternato con pulizia automatica
- Base per aggancio sistema TSTAK



IN DOTAZIONE IL KIT PULIZIA PAVIMENTI DWV9350-XJ

**570<sup>00</sup> €**  
+ IVA

**PERFORM PROTECT**

**AIR LOCK**



## DWV902L-QS ASPIRATORE A FILO SOLIDI/LIQUIDI 35LT CLASSE L 1400W

- Sistema a doppio filtro alternato con pulizia automatica
- Tubo flessibile 4metri con Ø 35mm

**60<sup>00</sup> €**  
+ IVA



## DWH201D-XJ SET DI SISTEMA ESTRAZIONE POLVERI TRAPANI A FILO E TASSELLATORI SDS-PLUS

## DWH161D1-QW ASPIRATORE UNIVERSALE 18V XR 2.0AH

- Compatibile con gli utensili di tutti i marchi
- Motore Brushless e filtro HEPA
- Sistema di pulizia manuale del filtro
- Wireless Tool Control
- Peso 1,7 kg

DOTAZIONE: 1 batteria 18V XR 2.0 Ah, caricabatterie, tubo flessibile da 1m, tracolla, gancio per cintura, valigetta Tstak

**PERFORM PROTECT**

**WIRELESS TOOL CONTROL**

**HEPA FILTER**



**IDEALE PER FORATURA**

**280<sup>00</sup> €**  
+ IVA



## DCV501LN-XJ ASPIRATORE A BATTERIA XR 18V CLASSE L

- Portata max aria 1260 litri/min
- Aspirazione con azione ciclonica
- Serbatoio in policarbonato 0.75 litri
- Tubo flessibile Antistatico
- Filtro HEPA lavabile
- Luce LED
- Peso 1.5 kg

DOTAZIONE: Spazzola per pavimenti, tubo flessibile, tubo di prolunga, lancia per fessure, spazzola larga, spazzola tonda, gancio per cintura, senza batteria e caricabatteria, borsa in cordura.

**155<sup>00</sup> €**  
+ IVA



**DCV5011H-XJ FILTRO HEPA DI RICAMBIO LAVABILE**

## PUNTE CON ASPIRAZIONE INTEGRATA



FORATURA RAPIDA DEL CALCESTRUZZO CON ESTRAZIONE DELLA POLVERE

### EXTREME PUNTE CAVE SDS-PLUS E SDS-MAX

FORATURA ESTREMAMENTE VELOCE

CORPO CAVO, PER UN'ELEVATA EFFICIENZA NELL'ESTRAZIONE DELLA POLVERE IN USO CON L'ASPIRATORE

DISPONIBILI ENTRAMBI GLI ATTACCHI SDS-PLUS E SDS-MAX

COLLEGAMENTO DIRETTO CON IL SISTEMA AIRLOCK

GEOMETRIA DELLA PUNTA PROGETTATA PER IL CORRETTO POSIZIONAMENTO, GARANTISCE PRECISIONE NEL LAVORO E MAGGIOR DURATA

**PERFORM PROTECT**



DESIGN A 2 TAGLIENTI (SDS-PLUS)



DESIGN CON TAGLIANTE A Y (SDS-MAX)

### PUNTE SDS-PLUS

CODICE	LU/LT	Ø	Prezzo s/IVA
DT60340-QZ	200 / 320mm	12 mm	82,5 €
DT60341-QZ	250 / 370mm	12 mm	91,8 €
DT60342-QZ	250 / 370mm	12 mm	93,8 €
DT60343-QZ	250 / 370mm	12 mm	98,4 €

### PUNTE SDS-MAX

CODICE	LU/LT	Ø	Prezzo s/IVA
DT60230-QZ	400 / 600mm	16 mm	187,5 €
DT60231-QZ	400 / 600mm	18 mm	192,2 €
DT60232-QZ	400 / 600mm	20 mm	201,5 €
DT60233-QZ	400 / 600mm	24 mm	210,9 €
DT60234-QZ	400 / 600mm	28 mm	276,5 €
DT60235-QZ	400 / 600mm	32 mm	285,9 €

# SPECIALE CARTONGESSO

## DCE555N-XJ REFILATORE PER CARTONGESSO BRUSHLESS 18V XR

- Velocità 26000 giri/min
- Regolazione di profondità
- Luce Led per illuminare l'area di lavoro

DOTAZIONE:  
2 pinze e frese da  
1/4" e 1/8",  
sistema di aspirazione



**165.<sup>00</sup> €**  
+ IVA

**619.<sup>00</sup> €**  
+ IVA



KIT ASPIRAZIONE AIRLOCK  
(NON IN DOTAZIONE)  
DWV9220-XJ

## DWE7800-QS LEVIGATRICE PER CARTONGESSO

- Diametro 225mm
- Velocità variabile 1400-2400 giri/min
- Lunghezza totale 1.6 mt
- Testa pivotante e platello forato per massimizzare l'esecuzione del lavoro e l'aspirazione
- Peso 4 kg

## CONSIGLIATO CON:

**DWF4000250**  
1.000 VITI  
NASTRATE  
3,5 x 25 mm

**15.<sup>80</sup> €**  
+ IVA



**345.<sup>00</sup> €**  
+ IVA

**2AH**



## DCF620D2K-QW AVVITATORE PER CARTONGESSO CON MECCANISMO CARICAMENTO VITI 18V XR 2AH

Guide di scorrimento migliorate per un ridotto rischio di inceppamento, maggiore protezione dalla polvere, design modificato per una maggiore accessibilità anche negli angoli.

- Coppia di serraggio 5-30 Nm
- Velocità a vuoto 0-4400 g/m
- Ridotto rischio di inceppamento,

DOTAZIONE: 2 batterie 18V XR 2Ah, caricabatterie, valigetta TSTAK

## DCE800T2-QW LEVIGATRICE PER CARTONGESSO

- Levigatura di stucco su pareti in cartongesso
- Diametro 225mm
- Velocità variabile
- Tubo telescopico fino a 1.6 metri
- Sistema Wireless Tool Control

DOTAZIONE:  
3 dischi abrasivi P150,  
2 batterie XR FV 6Ah,  
caricabatterie,  
Soft Bag



**990.<sup>00</sup> €**  
+ IVA



Massima efficienza del sistema di aspirazione



Velocità di lavoro regolabile con selettore



Testa pivotante per il massimo comfort in uso

## CONSIGLIATO CON:



ABRASIVO A MAGLIE  
PER LEVIGATRICI



**14.<sup>00</sup> €**  
+ IVA

CODICE	GRANA	Quantità
DTM8680-QZ	60	5
DTM8681-QZ	80	5
DTM8682-QZ	120	5
DTM8684-QZ	150	5
DTM8683-QZ	240	5

# SPECIALE SEGHE UNIVERSALI

## SEGA UNIVERSALE 54V XR FLEXVOLT

- Motore Brushless
- Corse al minuto 0-2800
- Lunghezza corsa 16mm
- Valigetta
- Caricabatterie rapido

XR FLEXVOLT



6 AH



DCS389T2-QW

720.<sup>00</sup> €

+ IVA

9 AH



DCS389X2-QW

825.<sup>00</sup> €

+ IVA



590.<sup>00</sup> €

+ IVA



DCS386H2T-QW SEGA UNIVERSALE  
18V POWERSTACK 5AH



565.<sup>00</sup> €

+ IVA



DCS367P2-QW SEGA UNIVERSALE  
18V XR 5AH



219.<sup>00</sup> €

+ IVA

DWE305PK-QS  
SEGA UNIVERSALE 1100W

## SEGHE ALLIGATOR®

### MATTONE

DT2976-QZ DT2974-QZ DT99591-QZ

Lama TCT 450 mm Alta densità	Lama TCT 450 mm Bassa densità	Lama FLEXVOLT HSS 450 mm Alta densità
------------------------------------	-------------------------------------	---

146. <sup>00</sup>	83. <sup>50</sup>	94. <sup>70</sup>
--------------------	-------------------	-------------------



### CALCESTRUZZO AREATO

DT2975-QZ

Lama TCT da 450 mm  
Calcestruzzo aerato

83.<sup>50</sup>



### LEGNO

DT2978-QZ DT99593-QZ

Lama HSS 450 mm Legno morbido e duro	Lama TCT 450 mm Legno morbido e duro
--	--

57. <sup>30</sup>	56. <sup>50</sup>
-------------------	-------------------



### ISOLAMENTO

DT2979-QZ

Lama HSS 450 mm  
Materiali isolanti

88.<sup>70</sup>



54V XR FLEXVOLT



910.<sup>00</sup> €

+ IVA



DCS398T2-QW SEGA ALLIGATOR 54V  
XR FLEXVOLT POROTON CLASSE 20

- Lunghezza lama 430mm
- Lunghezza corsa 40mm
- Corse/min 2400
- Freno lama 0.2 sec
- Peso 6.5 kg

DOTAZIONE: 2 batterie XR FV 6Ah,  
lama TCT per poroton classe 20,  
caricabatteria, chiave di servizio

465.<sup>00</sup> €

+ IVA



DWE398-QS SEGA ALLIGATOR  
1700W POROTON CLASSE 20

- Lunghezza lama 430mm
- Lunghezza corsa 40mm
- Corse/min 3000
- Peso 5.5 kg

DOTAZIONE: lama TCT per poroton  
classe 20, chiave di servizio

445.<sup>00</sup> €

+ IVA



DWE397-QS SEGA ALLIGATOR  
1700W POROTON CLASSE 12

- Lunghezza lama 430mm
- Lunghezza corsa 40mm
- Corse/min 3000
- Peso 5.5 kg

DOTAZIONE: lama TCT per poroton  
classe 12, chiave di servizio

# LAME PER SEGA UNIVERSALE BI-METAL



## DESIGN RESISTENTE

Le Lame Bi-Metal garantiscono maggiore flessibilità e lunga durata



## VERSATILITÀ E VELOCITÀ

Il design dei denti consente un taglio rapido su diversi tipi di materiale

# DURANO FINO AL 50% IN PIÙ<sup>(1)</sup>

<sup>(1)</sup> Prestazioni medie testate rispetto alla gamma precedente

CATEGORIE	LUNGHEZZE DISPONIBILI
Lame Bi-Metal per legno e legno con chiodi	152 / 228 / 305 mm
Lame Bi-Metal per metallo	100 / 152 / 203 / 305 mm
Lame Bi-Metal universali per legno, metallo e PVC	152 / 203 mm
Lame Bi-Metal per legno con chiodi ideali per demolizione	152 / 228 / 305 mm
Lame Bi-Metal per metallo duri e ad alto spessore	152 / 203 mm

## SCEGLI LA LAMA MIGLIORE

### LEGNO

LAME HCS	
DT2352-QZ	DT2432-QZ
Lunghezza (mm)	240 / 305
Lame per confezione	5 / 5
Numero di denti per pollice (TPI)	4 / 3
Prezzo €	31,60 / 21,60

LAME BI-METAL PER DEMOLIZIONE		
DT90380-QZ	DT90381-QZ	DT90382-QZ
Lunghezza (mm)	152 / 228 / 304	
Lame per confezione	5 / 5 / 5	
Numero di denti per pollice (TPI)	6 / 6 / 6	
Prezzo €	23,80 / 27,60 / 32,00	

LAME BI-METAL PLUNGEPOINT			
DT2351-QZ	DT2359-QZ	DT2349-QZ	DT2350-QZ
Lunghezza (mm)	152 / 152 / 228 / 305		
Lame per confezione	5 / 5 / 5 / 5		
Numero di denti per pollice (TPI)	6 / Legno tenero / 6 / Legno con chiodi / 6 / 6		
Prezzo €	20,40 / 20,40 / 24,60 / 29,20		

### METALLO

LAME BI-METAL STANDARD				
DT2385-QZ	DT2384-QZ	DT2361-QZ	DT2354-QZ	DT2353-QZ
Lunghezza (mm)	152 / 152 / 152 / 203 / 203			
Lame per confezione	5 / 5 / 5 / 5 / 5			
Numero di denti per pollice (TPI)	23 / 18 / 14 / 18 / 14			
Prezzo €	20,40 / 20,40 / 22,20 / 23,30 / 23,30			

LAME BI-METAL PER METALLI AD ALTO SPESSORE						
DT90384-QZ	DT90385-QZ	DT90386-QZ	DT90387-QZ	DT90388-QZ	DT90389-QZ	DT90390-QZ
Lunghezza (mm)	152 / 152 / 228 / 228 / 228 / 304 / 304					
Lame per confezione	5 / 5 / 5 / 5 / 5 / 5 / 5					
Numero di denti per pollice (TPI)	10 / 14 / 10 / 14 / 18 / 10 / 14					
Prezzo €	15,60 / 16,50 / 20,10 / 20,10 / 21,00 / 25,60 / 26,30					

### UTILIZZI SPECIALI

LAME PER MATERIALI ISOLANTI		
DT2450-QZ	DT2451-QZ	DT2452-QZ
Lunghezza (mm)	225 / 300 / 400	
Lame per confezione	2 / 2 / 1	
Numero di denti per pollice (TPI)	6 / 6 / 6	
Materiali	- / - / -	
Prezzo €	37,90 / 50,60 / 47,70	

LAME PER MATERIALI SPECIALI	
DT2332-QZ	DT2333-QZ
Lunghezza (mm)	152 / 228
Lame per confezione	1 / 1
Numero di denti per pollice (TPI)	23 / 18
Materiali	Ghisa, vetroresina, resine epossidiche, legno con chiodi, mattoni rossi
Prezzo €	11,20 / 14,90

# LAME PER SEGA UNIVERSALE BI-METAL CON DENTI AL CARBURO

## TAGLI RAPIDI SUL METALLO

Il rivestimento in Titanio rende i denti più forti e più affilati per un taglio veloce



## PROGETTATO PER GARANTIRE PRESTAZIONI DI TAGLIO SUPERIORI

Elevata capacità di taglio su diversi metalli come metalli ad altro spessore, ghisa e acciaio inossidabile

## TAGLIO DRITTO

### IN DIVERSI DIAMETRI

Profilo della lama lungo e spesso ideale per tagli dritti e una maggiore durata delle prestazioni di taglio

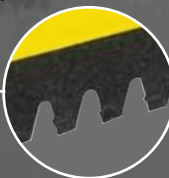

## DENTI AL CARBURO

Il Carburo ad alte prestazioni saldato ai denti garantisce una maggior resistenza e prevenire la perdita dei denti

**DURA FINO A 2X** IN PIÙ <sup>(2)</sup> RISPETTO A UNA LAMA TRADIZIONALE

<sup>(2)</sup> Prestazioni medie testate rispetto alla gamma precedente

CODICE	DESCRIZIONE	€ s/IVA
DT20440-QZ	Lama per sega universale con denti al carburo da 152 mm per legno con chiodi / 6TPI	16,40 €
DT20439-QZ	Lama per sega universale con denti al carburo da 230 mm per legno con chiodi / 6TPI	17,40 €
DT20438-QZ	Lama per sega universale con denti al carburo da 305 mm per legno con chiodi / 6TPI	26,40 €
DT20437-QZ	Lama per sega universale con denti al carburo da 102 mm per metallo / 8TPI	12,50 €
DT20436-QZ	Lama per sega universale con denti al carburo da 152 mm per metallo / 8TPI	16,40 €
DT20435-QZ	Lama per sega universale con denti al carburo da 230 mm per metallo / 8TPI	21,50 €

## IN BASE ALL'APPLICAZIONE

LAME EXTREME 2X LONG LIFE			LAME EXTREME XR RUNTIME		LAME EXTREME BI-METAL CON DENTI AL CARBURO		
DT2300L-QZ	DT2307L-QZ	DT2314L-QZ	DT99554-QZ	DT99555-QZ	DT20440-QZ	DT20439-QZ	DT20438-QZ
152	228	305	152	230	152	230	305
5	5	5	5	5	1	1	1
6	6	6	6	6	6	6	6
28,30	36,10	44,00	26,80	33,60	17,40	22,00	28,10

LAME EXTREME 2X LONG LIFE								LAME EXTREME XR RUNTIME		LAME EXTREME BI-METAL CON DENTI AL CARBURO		
DT90391-QZ	DT2315L-QZ	DT2301L-QZ	DT2308L-QZ	DT2316L-QZ	DT2407L-QZ	DT2408L-QZ	DT2409L-QZ	DT99553-QZ	DT99552-QZ	DT20437-QZ	DT20436-QZ	DT20435-QZ
304	100	152	228	305	152	203	305	152	230	102	152	230
5	5	5	5	5	5	5	5	5	5	1	1	1
18	10	10	14-18	10	14-18	14-18	14-18	14-18	14-18	8	8	8
26,60	20,30	26,50	33,10	42,90	29,50	37,50	49,70	30,60	38,30	13,30	17,40	22,90

LAME CON DENTI AL CARBURO GRIT				LAME BI-METAL A SPEZZARE	
DT2335-QZ	DT2420-QZ	DT2421-QZ	DT2422-QZ	DT2417-QZ	DT2416-QZ
228	240	305	457	152	230
1	1	1	1	5	5
14	18	14	14	14-18	14-18
Fibrocemento	Calcestruzzo arenato, mattoni, materiali alveolari			Tubi e profilati in metallo ed acciaio (max spessore 10mm)	
40,90	34,40	48,40	69,90	28,10	36,50

# SPECIALE SMERIGLIATRICI

**BRUSHLESS**



**226<sup>00</sup> €**  
+ IVA

**VELOCITÀ FISSA**

**DWE4347-QS SMERIGLIATRICE ANGOLARE 125mm**  
1700W / 10500 giri/min

**BRUSHLESS**



**237<sup>00</sup> €**  
+ IVA

**VELOCITÀ VARIABILE**

**DWE4357-QS SMERIGLIATRICE ANGOLARE 125mm**  
1700W / 2200 - 10500 giri/min

**BRUSHLESS**



**237<sup>00</sup> €**  
+ IVA

**IDEALE PER INOX**

**DWE4369-QS SMERIGLIATRICE ANGOLARE 125mm**  
1700W / 1800 - 8000 giri/min



**185<sup>00</sup> €**  
+ IVA

**PERFORM PROTECT**

**DWE4257-QS SMERIGLIATRICE ANGOLARE 125mm**  
1500W / 2800 - 10500 giri/min



**120<sup>00</sup> €**  
+ IVA

**DWE4237-QS SMERIGLIATRICE ANGOLARE 125mm**  
1400W / 11500 giri/min



**78<sup>00</sup> €**  
+ IVA

**DWE4156-QS SMERIGLIATRICE ANGOLARE 115mm**  
900W / 11500 giri/min



**190<sup>00</sup> €**  
+ IVA

**DWE4559-QS SMERIGLIATRICE ANGOLARE 230mm**  
2400W / 6500 giri/min



**190<sup>00</sup> €**  
+ IVA

**DWE492DU01-QS COPPIA DI SMERIGLIATRICI ANGOLARI**  
DWE4156-QS 115MM 900W + DWE492-QS 230MM 2200W



**308<sup>00</sup> €**  
+ IVA

**PERFORM PROTECT**

**DWE4257KT-QS SMERIGLIATRICE ELETTRONICA 125mm 1500W**  
CON CUFFIA E TAZZA PER CEMENTO



**240<sup>00</sup> €**  
+ IVA

**PERFORM PROTECT**

**DWE492GK-QS SMERIGLIATRICE ANGOLARE 230mm 2200W CON CUFFIA**  
DI ASPIRAZIONE E DISCO DIAMANTATO



DWE46225-XJ Ø 125mm  
**125<sup>00</sup> €**  
+ IVA

Ø 125mm

Ø 230mm

DWE46229-XJ

**180<sup>00</sup> €**  
+ IVA

**AIR CONTROL**

**PERFORM PROTECT**

**DWE46225-XJ / DWE46229-XJ CUFFIE DI ASPIRAZIONE PER SMERIGLIATRICI**

# ABRASIVI E ACCESSORI DIAMANTATI

## DISCHI DIAMANTATI SINTERIZZATI

### DISCO SEGMENTATO

#### MATERIALI RACCOMANDATI

Granito, Cemento, Pietra naturale, Clinker, Mattone refrattario, Ardesia, Arenaria



CODICE	MISURA	€ s/IVA
DT3701-QZ	115 x 7mm	11,40
DT3711-QZ	125 x 7mm	13,20
DT3731-QZ	230 x 7mm	41,10

### DISCO CORONA TURBO

#### MATERIALI RACCOMANDATI

Laterizio, Arenaria, Clinker, Calcestruzzo poroso, Pietra naturale

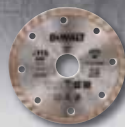

CODICE	MISURA	€ s/IVA
DT3702-QZ	115 x 7mm	11,40
DT3712-QZ	125 x 7mm	13,20
DT3732-QZ	230 x 7mm	41,10

### DISCO CORONA CONTINUA

#### MATERIALI RACCOMANDATI

Piastrelle in porcellana, Piastrelle in ceramica, Gres, Marmo



CODICE	MISURA	€ s/IVA
DT3703-QZ	115 x 5mm	10,20
DT3713-QZ	125 x 5mm	12,10
DT40207-QZ	230 x 5mm	37,40

## TAZZE DIAMANTATE

CARATTERISTICHE • Segmenti diamantati di grande dimensione per un'ottima durata  
• Alta concentrazione di grana diamantata per una grande velocità • Corpo in acciaio temprato

### CORONA SINGOLA



CODICE	MISURA	€ s/IVA
DT3795-QZ	125mm	44,70

### CORONA DOPPIA



CODICE	MISURA	€ s/IVA
DT3796-QZ	125mm	78,50

### CORONA TURBO



CODICE	MISURA	€ s/IVA
DT3797-QZ	125mm	83,40

### EXTREME METAL

## DISCHI DA TAGLIO per metalli per una durata estrema

1000+ TAGLI  
PER OGNI TIPO DI ACCIAIO  
Diametro in Abbraccio Legato

Progettati specificamente per fornire durata e prestazioni estreme. Questi dischi da taglio possono essere utilizzati con le smerigliatrici angolari a batteria e a filo, su una ampia gamma di metalli ferrosi e non.



N. CAT.	Ø	FORO	SPESSORE	€ s/IVA
DT40251-QZ	115mm	22,23mm	1,3mm	15,70
DT40252-QZ	125mm	22,23mm	1,3mm	19,30
DT40255-QZ	230mm	22,23mm	2,1mm	42,30

## DISCHI LAMELLARI



CODICE	MISURA	€ s/IVA
DT3292-QZ	115mm 36g	2,20
DT3293-QZ	115mm 60g	2,20
DT3294-QZ	115mm 80g	2,20
DT3308-QZ	125mm 36g	2,50
DT3309-QZ	125mm 60g	2,50
DT3310-QZ	125mm 80g	2,50

## DISCHI ABRASIVI

### HIGH PERFORMANCE

- Grana professionale in ossido di alluminio progettata per utensili a batteria per massimizzare la durata e le prestazioni.



CODICE	Ø	SPESSORE	MATERIALE	TIPO	€ s/IVA
DWA8062SIA-AE	115mm	1,2mm	INOX	Taglio	0,70
DWA8434SIA-AE	115mm	3mm	INOX	Taglio	0,90
DT42340Z-QZ	125mm	1,2mm	INOX	Taglio	0,90
DWA4522SIA-AE	125mm	3mm	INOX	Taglio	1,00
DT42380Z-QZ	180mm	1,2mm	INOX	Taglio	1,70
DWA4524SIA-AE	180mm	3mm	INOX	Taglio	1,70
DWA4525SIA-AE	230mm	3mm	INOX	Taglio	2,10
DWA4514IA-AE	115mm	6mm	METALLO	Sbavo	1,20
DW4543AIA-AE	125mm	6mm	METALLO	Sbavo	1,30
DW4547AIA-AE	180mm	6mm	METALLO	Sbavo	2,30
DW4549AIA-AE	230mm	6mm	METALLO	Sbavo	3,30

### EXTREME

- Grana industriale in ossido di alluminio progettata per massimizzare la durata e le prestazioni.
- Accreditato OSA.
- Concentrazione di grani ad alta densità per una maggiore durata.

### EXTREME



CODICE	Ø	SPESSORE	MATERIALE	TIPO	€ s/IVA
DT3442-QZ	115mm	1mm	INOX	Taglio	0,90
DT43903-QZ	115mm	1,2mm	INOX	Taglio	0,90
DT43905-QZ	115mm	1,6mm	INOX	Taglio	0,90
DT43902-QZ	125mm	1mm	INOX	Taglio	1,20
DT43904-QZ	125mm	1,2mm	INOX	Taglio	1,20
DT43909-QZ	230mm	2mm	INOX	Taglio	2,40
DX7921-AE	115mm	6mm	METALLO	Sbavo	1,40
DX7941-AE	125mm	6mm	METALLO	Sbavo	1,60
DT43919-QZ	230mm	6mm	METALLO	Sbavo	3,60

**535<sup>00</sup> €**

+ IVA

**DCS570P2-QW SEGA CIRCOLARE  
184MM 18V XR 5AH**

- Max prof. di taglio 90/45° 65/45mm
- Max inclinazione di taglio fino a 57°

DOTAZIONE: lama, 2 batterie 18V XR 5Ah, caricabatterie, guida parallela, chiave servizio, adattatore aspirazione, TSTAK

**265<sup>00</sup> €**

+ IVA

**DWE576K-QS  
SEGA CIRCOLARE 190MM 1600W**

- Max prof. taglio a 90/45° 61/49mm
- Max inclinazione testa 57°
- Scarpa in all., utilizzo con guida rettilinea
- Valigetta

**159<sup>00</sup> €**

+ IVA

**DWE560-QS  
SEGA CIRCOLARE 184MM 1350W**

- Max prof. taglio a 90/45° 65/42mm
- Max inclinazione testa 48°

**475<sup>00</sup> €**

+ IVA

**DCS565P2-QW SEGA  
CIRCOLARE COMPATTA  
BRUSHLESS 165MM 18V XR 5AH**

- Max inclinazione testa 50°
- Max prof. taglio 90/45° 55/42mm
- Freno elettronico
- Luce Led

DOTAZIONE: lama tct 24 denti, 2 batterie 18V XR 5Ah, caricabatterie, guida parallela, chiave di servizio, adattatore aspirazione AirLock, TSTAK

**139<sup>00</sup> €**

+ IVA

**DWE349-QS SEGHEtto  
ALTERNATIVO IMPUGNATURA  
A STAFFA 650W**

- Corse min 500-3200
- Lunghezza corsa 20mm
- Pulsante Lock-On
- Max taglio legno/alluminio/acciaio 85/20/10 mm
- Pendolarismo 4 posizioni
- Cambio lama e inclinazione base senza utensili

DOTAZIONE: adattatore scarpa antigraffio, in scatola di cartone

**540<sup>00</sup> €**

+ IVA

**DCS334P2-QW  
SEGHEtto ALTERNATIVO  
18V XR 5AH  
IMPUGNATURA A STAFFA  
BRUSHLESS**

- Corse min 0-3200
- Lunghezza corsa 26 mm
- Max taglio legno/acciaio 135/10mm

DOTAZIONE: accessorio per aspirazione, protezione antigraffio, inserto antisceggia

**540<sup>00</sup> €**

+ IVA

**DCS335P2-QW  
SEGHEtto ALTERNATIVO  
18V XR 5AH  
IMPUGNATURA SUL CORPO  
BRUSHLESS**

- Corse min 1000-3200
- Lunghezza corsa 26 mm
- Max taglio legno/acciaio 135/10mm

DOTAZIONE: accessorio per aspirazione, protezione antigraffio, inserto antisceggia

**255<sup>00</sup> €**

+ IVA

**DW331KT-QS  
SEGHEtto ALTERNATIVO  
701W  
IMPUGNATURA A STAFFA**

- Corse min 800-3100
- Max taglio legno /alluminio/acciaio 130/20/10mm

DOTAZIONE: 4 lame, accessorio per aspirazione, protezione antigraffio, inserto antisceggia

**255<sup>00</sup> €**

+ IVA

**DW333KT-QS  
SEGHEtto ALTERNATIVO  
701W  
IMPUGNATURA SUL CORPO**

- Corse min 800-3100
- Max taglio legno /alluminio/acciaio 130/20/10mm

DOTAZIONE: 4 lame, accessorio per aspirazione, protezione antigraffio, inserto antisceggia





# LEGNO



**160<sup>.00</sup> €**  
+ IVA

## DCE530N-XJ PISTOLA TERMICA 18V XR

Versione senza batterie  
e caricabatteria in  
scatola di cartone



**214<sup>.00</sup> €**  
+ IVA

## DWE315KT-QS MULTIFUNZIONE AD OSCILLAZIONE 300W

- Orbite/min 0-22000
- Angolo oscillazione 1.6°
- Aggancio rapido accessori
- Luce LED

DOTAZIONE: vari accessori, TSTAK



**482<sup>.00</sup> €**  
+ IVA

## DCS356P2-QW MULTIFUNZIONE AD OSCILLAZIONE 18V XR 5AH

- Orbite/min 0-15000/17000/20000
- Aggancio rapido accessori
- Luce LED

DOTAZIONE: accessori, 2 batterie 18V XR 5Ah,  
caricabatterie, TSTAK



**93<sup>.00</sup> €**  
+ IVA

## D26414-QS PISTOLA TERMICA DIGITALE 2000W

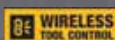

**390<sup>.00</sup> €**  
+ IVA



## DCW200P2-QW LEVIGATRICE ORBITALE ¼ DI FOGLIO 18V XR 5AH

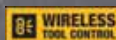

**405<sup>.00</sup> €**  
+ IVA



## DCW210P2-QW LEVIGATRICE ROTO-ORBITALE 125MM 18V XR 5AH

**250<sup>.00</sup> €**  
+ IVA



## DW682K-QS FRESATRICE PER LINGUETTE 600W



**152<sup>.00</sup> €**  
+ IVA

## DWE6411Z-IT LEVIGATRICE ORBITALE ¼ DI FOGLIO 230W + PIASTRA PER PERSIANE



**135<sup>.00</sup> €**  
+ IVA

## DWE6423-QS LEVIGATRICE ROTO-ORBITALE 125mm 280W



**230<sup>.00</sup> €**  
+ IVA

## DW680-QS PIALLETTO 600W



**385<sup>.00</sup> €**  
+ IVA

## D26204K-QS ELETTRIFRESATRICE BASE FISSA E AD AFFONDAMENTO 900W

- Velocità 16000÷27000 giri/min
- Diametro pinza 6÷8mm
- Max diametro fresa 36mm
- Max prof. di affondamento 55mm



**540<sup>.00</sup> €**  
+ IVA

## DWE625-QS ELETTRIFRESATRICE ELETTRONICA 12.7MM 2300W

- Velocità 9.000-22.000 Giri/min
- Diametro pinza 6 - 12.7mm
- Max diametro fresa 50mm
- Max affondamento 80mm



**595<sup>.00</sup> €**  
+ IVA

## DWE627KT-QS ELETTRIFRESATRICE ELETTRONICA 12.7MM 2300W CON INTERRUPTORE DI SICUREZZA

- Velocità 9.000-22.000 Giri/min
- Diametro pinza 6 - 12.7mm
- Max diametro fresa 50mm
- Max affondamento 80mm

## EXTREME WORKSHOP LEGNO



- CARBURO PREMIUM C4  
Fino a 5 riaffilature
- LAMA TAGLIATA AL LASER  
Ottimo equilibrio
- FESSURE D'ESPANSIONE  
Minor flessione del disco
- FESSURE ARMONICHE  
Riduzione del rumore
- DENTI IN CARBURO ULTRA AFFILATI
- ANGOLI DI AFFILATURA OTTIMIZZATI  
Minor rischio di scheggiatura

## EXTREME



- CARBURO DI NUOVA GENERAZIONE C3  
Fino a 3 riaffilature (vs gamma Construction)
- FESSURE D'ESPANSIONE RIEMPIE DI RESINA  
Riduce rumore e vibrazioni
- DENTE SOTTILE  
Minor sforzo, ideale per seghe cordless
- CORPO PIENO  
Ridotta ondulazione, taglio più dritto
- DENTI IN CARBURO ULTRA AFFILATI
- ANGOLI AFFILATURA OTTIMIZZATI  
Ridotto rischio di scheggiatura

## XR EXTREME RUNTIME



- IDEALI PER SEGHE A BATTERIA  
Doppio dei tagli con una carica, per utensili FlexVolt
- CARBURO DI NUOVA GENERAZIONE C3  
Fino a 3 riaffilature
- DENTE SOTTILE  
Minor sforzo, ideale per seghe cordless
- CORPO PIENO Ridotta ondulazione, taglio più dritto
- FESSURE D'ESPANSIONE  
Riduce rumore e vibrazioni
- ANGOLI D'AFFILATURA BREVETTATI  
Tagli più veloci con minor sforzo

## TABELLA COMPARATIVA

### MATERIALI CONSIGLIATI

	LEGNO DURO		PANNELLI RIVESTITI
	LEGNO		PLASTICA
	LEGNO CON CHIODI		ALLUMINIO
	LEGNO MORBIDO		METALLO/ACCIAIO
	COMPENSATO		ACCIAIO INOX
	LAMINATO		MATERIALE COMPOSITO
	MDF		FIBRO CEMENTO
	IMPIALLACCIATO		

CODICE	Ø LAMA/FORO MM	N° DENTI	GEOMETRIA DENTE	ANGOLO DENTE	LAMA	TIPO TAGLIO	€
DT1930-QZ	152/20	24	Alternato	10°	Construction / Edilizia	Universale	18,60
DT1931-QZ	160/20	18	Alternato	20°	Construction / Edilizia	Extra Veloci	17,60
DT1932-QZ	160/20	30	Alternato	10°	Construction / Edilizia	Universale	19,40
DT1086-QZ	165/20	48	Trapezoidale	5°	LEGNO	Puliti	62,90
DT1090-QZ	165/20	48	Alternato	5°	LEGNO	Puliti	53,10
DT1934-QZ	165/20TK*	24	Alternato	10°	Construction / Edilizia	Universale	18,70
DT1935-QZ	165/20	30	Alternato	10°	Construction / Edilizia	Universale	19,70
DT1937-QZ	165/30	30	Alternato	10°	Construction / Edilizia	Universale	21,30
DT1942-QZ	184/30	30	Alternato	10°	Construction / Edilizia	Universale	24,00
DT4092-QZ	184/16	48	Trapezoidale	-5°	LEGNO	Ultra puliti	82,60
DT10302-QZ	184/16	24	Alternato	18°	EXTREME® LEGNO	Universale	37,40
DT10303-QZ	184/16	40	Alternato	18°	EXTREME® LEGNO	Puliti	47,40
DT1943-QZ	190/30	18	Alternato	20°	Construction / Edilizia	Extra Veloci	24,20
DT1944-QZ	190/30TK*	24	Alternato	16°	Construction / Edilizia	Universale	24,90
DT1945-QZ	190/30	40	Alternato	10°	Construction / Edilizia	Universale	26,20
DT4094-QZ	190/30	48	Trapezoidale	-5°	LEGNO	Ultra puliti	76,80
DT10304-QZ	190/30	24	Alternato	18°	EXTREME® LEGNO	Universale	38,30
DT99562-QZ	190/30	24	Alternato	25°	XR EXTREME RUNTIME	Universale	43,10
DT99563-QZ	190/30	36	Alternato	25°	XR EXTREME RUNTIME	Puliti	58,00
DT4394-QZ	190/30	40	Alternato	10°	EXTREME® LEGNO	Puliti	61,30
DT1954-QZ	235/30	24	Alternato	20°	Construction / Edilizia	Extra Veloci	27,10
DT1938-QZ	184/16	18	Alternato	20°	Construction / Edilizia	Extra Veloci	20,40
DT1939-QZ	184/16	24	Alternato	16°	Construction / Edilizia	Universale	22,10
DT1940-QZ	184/16	24	Alternato	10°	Construction / Edilizia	Universale	24,00
DT1472-QZ	190/30	4	Piatto	12°	EXTREME® MULTIMATERIAL		63,00
DT1957-QZ	250/30	48	Alternato	10°	Construction / Edilizia	Universale	36,40
DT4287-QZ	250/30	80	Trapezoidale	-5°	LEGNO	Ultra puliti	98,10
DT4351-QZ	250/30	60	Alternato	10°	LEGNO	Puliti	103,00
DT1474-QZ	250/30	12	Piatto	12°	EXTREME® MULTIMATERIAL		206,00
DT4280-QZ	260/30	80	Trapezoidale	-5°	LEGNO	Ultra puliti	92,40
DT1916-QZ	305/30	80	Trapezoidale	-5°	METALLO	Extra Veloci	184,80
DT1959-QZ	305/30	48	Alternato	10°	Construction / Edilizia	Universale	51,50
DT1960-QZ	305/30	60	Alternato	-5°	Construction / Edilizia	Universale	55,60
DT4218-QZ	305/30	72	Incaavato	10°	LEGNO	Ultra puliti	151,20
DT4260-QZ	305/30	60	Alternato	-5°	LEGNO	Puliti	88,30
DT4288-QZ	305/30	80	Trapezoidale	-5°	LEGNO	Extra Veloci	123,40
DT4290-QZ	305/30	96	Trapezoidale	-5°	LEGNO	Extra Veloci	135,70
DT4331-QZ	305/30	60	Alternato	-5°	LEGNO	Puliti	116,10
DT4340-QZ	305/30	48	Alternato	10°	LEGNO	Puliti	87,50
DT1926-QZ	355/25.4	66	Trapezoidale	1,5°	METALLO	Extra Veloci	190,50
DT1927-QZ	355/25.4	90	Trapezoidale	1,5°	METALLO	Extra Veloci	210,10
DT1922-QZ	355/25.4	90	Trapezoidale	10°	METALLO	Extra Veloci	340,10

# LAME CIRCOLARI

## COSTRUCTION / EDILIZIA

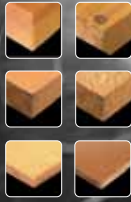

- **CARBURIO C2**  
Maggior resistenza a scheggiature e rotture
- **DENTE SOTTILE**  
Minor sforzo, ideale per seghe cordless
- **CORPO PIENO**  
Ridotta ondulazione, taglio più dritto
- **DENTI ULTRA AFFILATI**  
Minor rischio di scheggiatura

## MULTI MATERIAL



- **FESSURE ANTIVIBRAZIONE**  
Miglior finitura del taglio e riduzione del rumore



## METALLO



### ACCIAIO

Realizzato con il 12% di carburo di titanio, tagliano CON FACILITÀ l'acciaio. Denti trapezoidali per tagli puliti e senza sbavature. Fessure d'espansione per dissipare il calore e tripla brasatura garantiscono maggior resistenza prolungandone la durata.



### ACCIAIO INOSSIDABILE (Inox)

Realizzate in carburo per tagliare con facilità acciaio ed acciaio inossidabile, per durare a lungo e ridurre le scheggiature.



### ALLUMINIO

Per tagliare alluminio e metalli non ferrosi inclusi ottone e rame. I denti in carburo di tungsteno mantengono a lungo l'affilatura ed un bordo antiaderente riduce l'attrito. Lo spessore dei denti permette tagli veloci ed ultra-sottili.

LEGNO DURO	LEGNO	LEGNO CON CHIODI	LEGNO MORBIDO	COMPENSATO	LAMINATO	MDF	IMPIALLACCIATO	PANNELLI RIVESTITI	PLASTICA	ALLUMINIO	METALLO/ACCIAIO	ACCIAIO INOX	COMPOSITO DECK	FIBRO CEMENTO	CODICE
	•		•												DT1930
	•		•												DT1931
	•		•												DT1932
•	•		•	•	•	•									DT1086
•	•		•												DT1090
	•	•	•												DT1934
	•	•	•												DT1935
	•	•	•												DT1937
	•	•	•												DT1942
							•	•	•	•					DT4092
•				•	•	•									DT10302
•				•	•	•									DT10303
	•	•	•												DT1943
	•	•	•												DT1944
	•	•	•												DT1945
							•	•	•	•					DT4094
•				•	•	•									DT10304
•			•	•	•	•									DT99562
•			•	•	•	•									DT99563
•			•	•	•	•							•		DT4394
	•	•	•												DT1954
	•	•	•												DT1938
	•	•	•												DT1939
	•	•	•												DT1940
														•	DT1472
	•	•	•												DT1957
•	•		•	•	•	•	•	•	•	•					DT4287
															DT4351
														•	DT1474
							•	•	•	•					DT4280
	•	•	•								•				DT1916
	•	•	•												DT1959
	•	•	•												DT1960
								•							DT4218
•				•	•	•									DT4260
							•	•	•	•					DT4288
							•	•	•	•					DT4290
•				•	•	•									DT4331
•	•			•	•	•									DT4340
											•				DT1926
											•				DT1927
												•			DT1922

# PRODUCIAMO IN ITALIA - dal 1969

Oltre 50 anni di esperienza si uniscono alla continua ricerca di innovazione e eccellenza, e rendono lo stabilimento DEWALT di Perugia all'avanguardia nell'Industria 4.0

## Lo sapevi che...

Lo stabilimento DEWALT Industrial Tools di Perugia è specializzato nella produzione di elettrotensili professionali, iniziata nel 1969 con troncatrici e seghe combinate.

Oggi i prodotti realizzati, sia a filo che a batteria, sono ancora principalmente per il settore della lavorazione legno (troncatrici, seghe a banco, rifilatori) ma anche per l'edilizia (martelli demolitori) e la carpenteria metallica.



**DWS774-QS**  
TRONCATRICE  
RADIALE  
216MM  
1600W

	X	Y	Z
90°/90°	250 mm	60 mm	20 mm / 70 mm
45°/90°	170 mm	60 mm	
90°/45°	250 mm	48 mm	



**415<sup>00</sup> €**  
+ IVA

**DWS771-QS**  
TRONCATRICE  
RADIALE  
216MM  
1600W

	X	Y	Z
90°/90°	270 mm	60 mm	
45°/90°	190 mm	60 mm	
90°/45°	270 mm	48 mm	



**645<sup>00</sup> €**  
+ IVA

**DWS778-QS**  
TRONCATRICE  
RADIALE  
250MM  
1600W

	X	Y	Z
90°/90°	305 mm	85 mm	15 mm / 90 mm
45°/90°	215 mm	85 mm	
90°/45°	305 mm	58 mm	



**660<sup>00</sup> €**  
+ IVA

**DW712-QS**  
TRONCATRICE  
RADIALE  
216MM  
1600W

	X	Y	Z
90°/90°	300 mm	70 mm	
45°/90°	212 mm	70 mm	
90°/45°	300 mm	50 mm	



**915<sup>00</sup> €**  
+ IVA

# MACCHINE STAZIONARIE

**DWS727-QS**  
TRONCATRICE  
RADIALE  
250MM  
1600W

	X	Y	T	X	Y	T
90° 90°	290 mm	90 mm	305 mm	77 mm	28 mm	150 mm
45° 90°	200 mm	90 mm	210 mm	77 mm	20 mm	150 mm
90° 45°	290 mm	60 mm	305 mm	50 mm		
45° 45°	200 mm	60 mm	210 mm	50 mm		



**915<sup>.00</sup> €**

+ IVA

**DWS780-QS**  
TRONCATRICE  
RADIALE  
305MM  
A DOPPIA  
INCLINAZIONE  
1675W

	X	Y	X	Y	T
90° 90°	303 mm	110 mm	345 mm	76 mm	
45° 90°	200 mm	112 mm	244 mm	76 mm	
90° 45°	268 mm	63 mm	345 mm	44 mm	



**1.150<sup>.00</sup> €**

+ IVA

**D27113-QS**  
TRONCATRICE  
TESTA FISSA  
CON PIANETTO  
305MM

**755<sup>.00</sup> €**

+ IVA



**D27112-QS**  
TRONCATRICE  
RADIALE  
CON PIANETTO  
305MM  
1600W

**950<sup>.00</sup> €**

+ IVA



**DE7033-XJ**  
CAVALLETTO  
DI SUPPORTO  
UNIVERSALE

**149<sup>.00</sup> €**

+ IVA



**DWE7485-QS**  
SEGA A BANCO  
210MM  
1850W

**629<sup>.00</sup> €**

+ IVA



**DWE7492-QS**  
SEGA A BANCO  
250MM  
2000W

**775<sup>.00</sup> €**

+ IVA



**D27107-QS**  
SEGA  
COMBINATA  
305MM  
2000W

**1.670<sup>.00</sup> €**

+ IVA



**D27300-QS**  
PIALLA A FILO  
E SPESSORE  
2100W

**1.899<sup>.00</sup> €**

+ IVA



**DW733-QS**  
PIALLA A  
SPESSORE  
317MM  
1800W

**799<sup>.00</sup> €**

+ IVA



# SPECIALE PNEUMATICA

## DPC17PS-QS COMPRESSORE 17 LT CON RUOTE

- Motore senza olio
- Potenza motore 2.5Hp/1.8Kw
- Aria aspirata 240 Lt/min
- Pressione massima 13.8 Bar
- FAD 141 Lt/min @ 6.23Bar
- 2 connettori uscita aria EU universali
- Maniglia telescopica
- DOTAZIONE:  
Tubo flessibile 10Mt



**495.<sup>00</sup> €**

+ IVA



## DPC10RC-QS COMPRESSORE 10L

- Motore senza olio
- Potenza motore 2Hp
- Aria aspirata 216 Lt/min
- FAD 82 Lt/min
- Peso 17.5Kg
- DOTAZIONE:  
Tubo flessibile 10Mt



**280.<sup>00</sup> €**

+ IVA

## DPC6MRC-QS COMPRESSORE 6L

- Motore senza olio
- Potenza motore 1.5Hp
- Aria aspirata 170 Lt/min
- FAD 75 Lt/min
- Peso 10.5Kg
- DOTAZIONE: Tubo flessibile 5Mt



**208.<sup>00</sup> €**

+ IVA

## DPN90C-XJ CHIODATRICE 90mm

- Corpo in magnesio
- Regolazione profondità
- Lunghezza chiodo 50-90mm
- Ø Chiodo 2.5-3.1mm
- Testa chiodo 7.2mm
- Valigetta



**450.<sup>00</sup> €**

+ IVA

## DPN1850PP-XJ GROPPINATRICE 18G Precision point

- Sistema senza olio
- Corpo in magnesio
- Regolazione profondità
- Larghezza groppino 1.2mm
- Lunghezza groppino 15-50mm
- Valigetta



**150.<sup>00</sup> €**

+ IVA

## DPN2330-XJ GROPPINATRICE 23G

- Corpo in alluminio
- Regolazione potenza
- Scarico aria posteriore
- Larghezza groppino 0.6mm
- Lunghezza groppino 10-30mm
- Valigetta



**153.<sup>00</sup> €**

+ IVA

## DPS8016-XJ CUCITRICE SERIE 80

- Corpo in alluminio
- Regolazione potenza
- Scarico aria posteriore
- Larghezza graffa 12.8mm
- Lunghezza graffa 4-16mm
- Valigetta



**182.<sup>00</sup> €**

+ IVA

# APPLICAZIONI SPECIALI

## D36000-QS TAGLIAPIASTRELLE AD ACQUA 1600W

- Ø lama/foro 254/25.4 mm
- Velocità 4200 Giri/min
- Max prof. taglio 80mm
- Max cap. di taglio 940mm
- Max cap. di taglio diagonale 635mm

DOTAZIONE: Vasca e supporti laterali raccogli acqua, pompa acqua.



**1.350<sup>.00</sup> €**  
+ IVA



**IN DOTAZIONE  
GAMBE DI  
SUPPORTO  
D240001-XJ**

## DCN662D2-QW GROPPINATRICE 16GA BRUSHLESS 18V XR 2AH

- Lunghezza chiodi: 32-64mm
- Ø chiodi: 1.6mm
- Angolazione chiodi: 0°

DOTAZIONE: 2 batterie 18V XR 2Ah, caricabatterie e valigetta



**18V  
BRUSHLESS XR**

**680<sup>.00</sup> €**  
+ IVA

## DWD024KS-QS TRAPANO A PERCUSSIONE 701W

- Velocità 0-2600 giri/min
- Coppia 12Nm
- Mandrino 1.5-13 mm
- In valigetta



**109<sup>.00</sup> €**  
+ IVA

## DCN45RND2-QW CHIODATRICE PER TETTI E MANUTENZIONE GENERALE 18V XR 2AH

- Lugh. chiodi: 19-45 mm
- Ø chiodi: 3.1mm
- Angolazione chiodi: 15°
- Capacità: 120 chiodi
- Velocità: 3 chiodi/sec

DOTAZIONE: 2 batterie 18V XR 2Ah, caricabatterie e valigetta



**18V  
BRUSHLESS XR**

**725<sup>.00</sup> €**  
+ IVA



## DWD241-QS MISCELATORE DOPPIA IMPUGNATURA 1800W

- 3 velocità  
225-725 giri/min
- Attacco femmina M14
- Max Ø frusta 160mm



**249<sup>.00</sup> €**  
+ IVA

## DCN890P2-QW CHIODATRICE BRUSHLESS PER CEMENTO 18V XR 5AH

- Lugh. chiodi: 13-57mm
- Ø chiodi: 2.6-3.7mm
- Angolazione chiodi: 15°
- Capacità: 30 chiodi
- Velocità: 3 chiodi/sec

DOTAZIONE: 2 batterie 18V XR 5Ah, caricabatterie e valigetta



**18V  
BRUSHLESS XR**

**955<sup>.00</sup> €**  
+ IVA



**180<sup>.00</sup> €**  
+ IVA

## DWC410-QS TAGLIAPIASTRELLE AD ACQUA 110MM 1300W

- Velocità 13000 giri/min
- Max profondità taglio 90/45° 34/19mm



**255<sup>.00</sup> €**  
+ IVA

## DWD524KS-QS TRAPANO PERCUSSIONE 1100W

- 2 Velocità 0-1250/3500 giri/min
- Coppia serraggio 40/20 Nm
- Frizione meccanica
- Valigetta



**322<sup>.00</sup> €**  
+ IVA

## D21570K-QS TRAPANO PERCUSSIONE / CAROTATORE A SECCO 1300W

- Mandrino 1-16mm
- 2 Velocità 0-1250/3500 giri/min
- Max Ø corona diamantata 127mm
- Valigetta

**PERFORM  
PROTECT**



### MARTELLO XP

CODICE	DESCRIZIONE	€ s/IVA
DWHT51003-0	Martello gr 454	34,80 €
DWHT51004-0	Martello gr 567	37,20 €
DWHT51005-0	Martello gr 624	39,50 €



### LIVELLE A SEZIONE RETTANGOLARE

CODICE	DESCRIZIONE	€ s/IVA
DWHT0-43224	Livella 60 cm	34,80 €
DWHT0-43248	Livella 120 cm	50,30 €
DWHT0-43172	Livella 180 cm	75,40 €



**27<sup>50</sup> €**  
+ IVA

### DWHT0-43003 LIVELLA TORPEDO 25 CM

In alluminio estruso con 1 bolla verticale e 1 bolla orizzontale ad alta resistenza, inserite in una struttura in ABS rinforzato. Ulteriore bolla regolabile con indicazione dell'angolo di inclinazione + - 90°.



**17<sup>90</sup> €**  
+ IVA

### DWHT42525-0 LIVELLA TORPEDO COMPATTA 16,5 CM

In alluminio estruso con 1 bolla orizzontale 1 verticale e 1 ulteriore orizzontale con inclinazione di 1,5° per posa di tubi di drenaggio e grondaie. 3 magneti nella parte superiore.



### FLESSOMETRO TOUGH TAPE

CODICE	DESCRIZIONE	€ s/IVA
DWHT36917-0	Flessometro 5m nastro 32mm	25,20 €
DWHT36928-0	Flessometro 8m nastro 32mm	27,60 €



### FLESSOMETRO COMPATTO

CODICE	DESCRIZIONE	€ s/IVA
DWHT38114-0	Flessometro Compatto 5m - nastro 28 mm	16,20 €
DWHT38128-0	Flessometro Compatto 8m - nastro 28 mm	18,40 €



**5<sup>40</sup> €**  
+ IVA

### DWHT36098-1 FLESSOMETRO TASCABILE 3M

Flessometro tascabile da 3m compatto con nastro da 13mm. Clip d'aggancio alla cintura e inserto magnetico nella cassa. Ideale per uso quotidiano.



# UTENSILI MANUALI

**11<sup>.60</sup> €**

+ IVA



## DWHTO-10249 CUTTER AUTOBLOCCANTE MM 18

Con rotella bloccalama in punta per ulteriore sicurezza. Fornito con 3 lame a spezzare al Carburo di tungsteno. Barra porta lama in acciaio inox e caricamento automatico della lama. Il serbatoio può contenere fino a 6 lame.

**14<sup>.20</sup> €**

+ IVA



## DWHTO-10250 CUTTER AUTOBLOCCANTE MM 25

Con rotella bloccalama in punta per ulteriore sicurezza. Fornito con 3 lame a spezzare al Carburo di tungsteno. Barra porta lama in acciaio inox e caricamento automatico della lama. Il serbatoio può contenere fino a 6 lame.

**13<sup>.30</sup> €**

+ IVA



## DWHTO-10295 COLTELLO A LAMA RETRATTILE

Impugnatura bi-material e inserto poggia dito in gomma. Pulsante di regolazione della lama per varie profondità di taglio. Cambio lama rapido. Dotato di elemento taglia spago e di moschettone.

**20<sup>.70</sup> €**

+ IVA



## DWHTO-10313 COLTELLO SPORT PIEGHEVOLE

Coltello maneggevole, leggero con una lama uso intenso da 82 mm in acciaio inox con una parte seghettata per materiali più resistenti e per uso come spelafili.

**26<sup>.40</sup> €**

+ IVA



## DWHTO-20547 SEGHETTO PER METALLO "5 IN 1"

Con possibilità di inserire la lama direttamente nel manico o nel telaio per uso anche in spazi ristretti. Serbatoio per lame di ricambio all'interno del seghetto. Tensione della lama regolabile fino a 150 kg.

**9<sup>.00</sup> €**

+ IVA



## DWHT20327-0 MINISEGHETTO PER FERRO

Un utensile versatile e compatto con cambio lama senza utensili e possibilità di regolazione della tensione.



## MORSETTI A BARRA

CODICE	DESCRIZIONE	€ s/IVA
DWHTO-83192	Morsetto a barra mm 150 kg 135	19,80 €
DWHTO-83193	Morsetto a barra mm 300 kg 135	22,20 €
DWHTO-83194	Morsetto a barra mm 600 kg 135	25,70 €
DWHTO-83195	Morsetto a barra mm 910 kg 135	28,70 €
DWHTO-83185	Morsetto a barra XL mm 300 kg 272	30,60 €
DWHTO-83186	Morsetto a barra XL mm 600 kg 272	39,50 €
DWHTO-83187	Morsetto a barra XL mm 910 kg 272	44,30 €

**58<sup>.60</sup> €**

+ IVA



## DWMT81610-0 SET 50 PZ CHIAVI A BUSSOLA COMPATTO ATTACCO 1/4"

Set composto da chiavi a bussola esagonali con attacco 1/4" mm 4, 4,5, 5, 5,5, 6, 7, 8, 9, 10, 11, 12, 13, 14.

Chiavi a bussola esagonali in pollici con attacco 1/4" SAE 5/32", 3/16", 7/32", 1/4", 9/32", 5/16", 11/32", 3/8", 7/16", 1/2", 9/16"

Accessori: Cricchetto 72 denti att. 1/4"; Prolunga mm 75 attacco 1/4"; Prolunga mm 150 att. 1/4"; Maniglia porta bussole; Bussola porta inserti; 22 inserti

# SISTEMI PORTAUTENSILI

## **TOUGHSYSTEM® 2.0**

### IN CONDIZIONI ESTREME



ELEVATO SPAZIO  
INTERNO UTILE



SISTEMA  
AGGANCI/SGANCIO  
LATERALE BREVETTATO



CHIUSURE FRONTALI  
RINFORZATE

## ADATTATORE **TOUGHSYSTEM®**

**TSTAK™**  
COMPATIBLE

**TOUGH  
CASE+**  
COMPATIBLE

**TOUGHSYSTEM®**  
COMPATIBLE

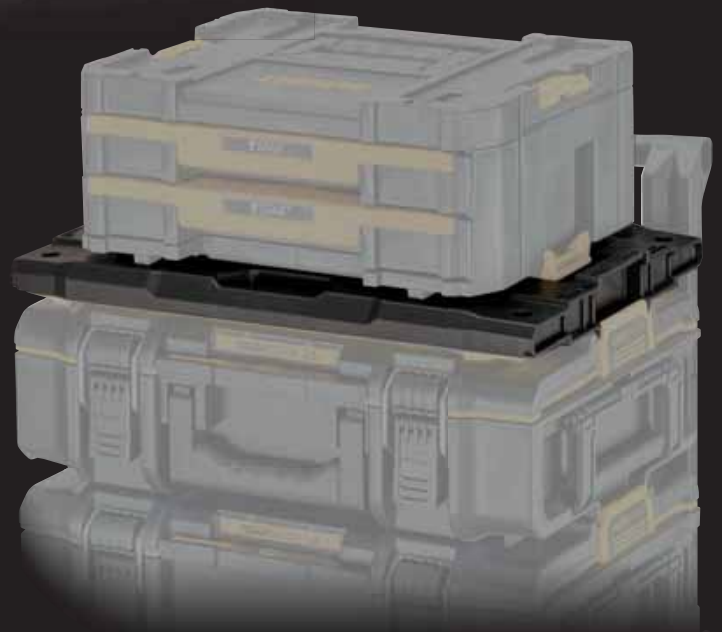

## **TSTAK™**

### COMPONI I PORTAUTENSILI



IP54 PROTEZIONE  
ACQUA/POLVERI



CHIUSURE  
METALLICHE  
MAGGIORATE



AGGANCI/SGANCIO  
LATERALE CON  
SPINA METALLICA



ALLOGGIAMENTO  
PER TAG DI  
LOCALIZZAZIONE



NOVITÀ

**229.<sup>00</sup> €**  
+ IVA

NOVITÀ

**TOUGHSYSTEM®**

IP55 



**DWST83471-QW  
VALIGIA CARICABATTERIA A 2 INGRESSI**

- 2 postazioni di ricarica simultanee 4°
- Alloggiamento batteria di scorta
- Indicatore stato di carica interno ed esterno
- Ventilazione combinata
- Porta USB 1X Type A, 1X Type C
- Chiusura in metallo
- Formato mezzo modulo

**45.<sup>00</sup> €**  
+ IVA

**TOUGHSYSTEM®**

IP65 



**DWST08035-1  
MEZZO FONDO TOUGHSYSTEM**

- Vasca interna amovibile
- Divisori interni
- Cerniere e chiusure in acciaio
- Formato mezzo modulo

**109.<sup>00</sup> €**  
+ IVA

NOVITÀ

**TSTAK™**

IP54 



**DWST17871-1  
BAULE CON RUOTE**

- Capacità 136 lt
- Doppia apertura, totale o apertura superiore ad accesso rapido
- Doppio occhiello per lucchetto
- Maniglione a scomparsa
- Cerniere e chiusure in acciaio

**119.<sup>00</sup> €**  
+ IVA

NOVITÀ



**DWST08017-9  
COMBINATA TOUGHSYSTEM - TSTAK**

- Cassetta portautensili media Toughsystem DWST83294-1
- Adattatore Toughsystem-TSTAK DWST08017-1
- Valigia fonda TSTAK DWST83346-1

**DWST08017-1  
ADATTATORE TOUGHSYSTEM - TSTAK**

Consente di adattare i moduli del sistema Tstak a quelli Toughsystem 2.0 anche nella misura 1/3 e 2/3

**19.<sup>00</sup> €**  
+ IVA

NOVITÀ

**TSTAK™  
COMPATIBLE**

**TOUGH  
CASE+  
COMPATIBLE**

**TOUGHSYSTEM®  
COMPATIBLE**



## TOUGHSYSTEM® 2.0

**TOUGHSYSTEM®**  
COMPATIBLE



**105.<sup>00</sup> €**  
+ IVA

**DWST83522-1**  
BORSA TRACCOLLA 22"  
NYLON 1600DEN  
MULTITASCHE

**TOUGHSYSTEM®**  
COMPATIBLE



**85.<sup>00</sup> €**  
+ IVA

**DWST83524-1**  
BORSA TRACCOLLA 11"  
NYLON 1600DEN  
MULTITASCHE



**31.<sup>00</sup> €**  
+ IVA

**DWST83392-1**  
MEZZO ORGANIZER



**58.<sup>00</sup> €**  
+ IVA

**DWST83394-1**  
UNITÀ ORGANIZER CON  
10 CONTENITORI PORTA MINUTERIA  
(2 GRANDI E 8 PICCOLI)



**56.<sup>00</sup> €**  
+ IVA

**DWST83293-1**  
PORTAUTENSILI BASSO  
555x385x180 mm



**64.<sup>00</sup> €**  
+ IVA

**DWST83294-1**  
PORTAUTENSILI MEDIO  
555x385x317 mm



**73.<sup>00</sup> €**  
+ IVA

**DWST83342-1**  
PORTAUTENSILI ALTO  
555x385x415 mm



**125.<sup>00</sup> €**  
+ IVA

**DWST83529-1**  
CASSETTA PORTA UTENSILI  
CON DOPIO CASSETTO  
305x355x535mm



**DWST83408-1**  
**13.<sup>00</sup> €**  
+ IVA

**DWST83407-1**  
**12.<sup>00</sup> €**  
+ IVA

**DWST83408-1**  
CONTENITORE INTERNO ALTO  
**DWST83407-1**  
CONTENITORE INTERNO BASSO



**130.<sup>00</sup> €**  
+ IVA

**DWST83295-1**  
VASCA CON RUOTE  
608x500x990 mm



**246.<sup>00</sup> €**  
+ IVA

**DWST83402-1**  
VASCA CON RUOTE +  
UNITÀ BASSA + UNITÀ MEDIA



**395.<sup>00</sup> €**  
+ IVA

**DWST83401-1**  
TOUGHSYSTEM 2.0  
COMPLETO

# TSTAK™

## E SOFT STORAGE

TSTAK™  
COMPATIBLE



42.<sup>00</sup> €  
+ IVA

**DWST83541-1**  
BORSA TRACCOLLA 1600DEN,  
MULTITASCHE



38.<sup>00</sup> €  
+ IVA

**DWST82968-1**  
ORGANIZER TSTAK V



52.<sup>00</sup> €  
+ IVA

**DWST83344-1**  
VALIGETTA CON  
MANIGLIONE TSTAK I



38.<sup>00</sup> €  
+ IVA

**DWST83345-1**  
VALIGETTA TSTAK II



49.<sup>00</sup> €  
+ IVA

**DWST1-70705**  
VALIGETTA CON  
CASSETTO TSTAK III



57.<sup>00</sup> €  
+ IVA

**DWST1-70706**  
VALIGETTA CON  
2 CASSETTI TSTAK IV



37.<sup>00</sup> €  
+ IVA

**DWST83346-1** VALIGETTA  
PROFONDA TSTAK VI



50.<sup>00</sup> €  
+ IVA

**DWST83343-1** VALIGETTA  
PROFONDA CON MANIGLIONE



74.<sup>00</sup> €  
+ IVA

**DWST83520-1** ORGANIZER  
+ VALIGIA PROFONDA



154.<sup>00</sup> €  
+ IVA

**DWST83517-1** TSTAK  
TOWER KIT COMPOSTO  
DA: VASCA CON RUOTE  
+ TSTAK V + TSTAK I



144.<sup>00</sup> €  
+ IVA

**DWST83411-1** TSTAK  
TOWER KIT COMPOSTO  
DA: VASCA CON RUOTE  
+ TSTAK V + TSTAK I



93.<sup>00</sup> €  
+ IVA

**DWST83347-1**  
VASCA FONDA  
CON RUOTE



141.<sup>00</sup> €  
+ IVA

**DWST1-71196**  
TROLLEY TSTAK



56.<sup>00</sup> €  
+ IVA

**DWST1-71229**  
CARRELLO TSTAK



83.<sup>00</sup> €  
+ IVA

**DWST81690-1**  
ZAINO BACKPAK



71.<sup>00</sup> €  
+ IVA

**DWST82991-1**  
BORSA TRACCOLLA  
RETTANGOLARE

COMPATIBILE  
TSTAK



71.<sup>00</sup> €  
+ IVA

**DWST82990-1**  
BORSONE APERTO  
RETTANGOLARE

COMPATIBILE  
TSTAK

# ACCESSORI LAVORAZIONE DEI METALLI

**EXTREME**

**95<sup>50</sup> €**  
+ IVA

**29 PEZZI**

**DT7926-XJ**  
**SET FORARE METALLO**

Cassetta con 29 punte Extreme2 per forare. Metallo diametri da 1 a 13mm.

**EXTREME**

**143<sup>90</sup> €**  
+ IVA

**29 PEZZI**

**DT4957-QZ**  
**SET FORARE ACCIAIO INOX**

Cassetta con 29 punte Extreme COBALT forare. Acciaio inox  $\varnothing$  da 1 a 13mm.

**PUNTE METALLO EXTREME2**

Adatte per forature su acciaio legato e non legato. Adatte per foratura su lamiere o materiali sottili dove sono richiesti fori senza sbavature. Ideali per utensili a filo o batteria fino a 900 N/mm<sup>2</sup>

CODICE	$\varnothing$	€ s/IVA
DT5038-QZ	2x3 mm	2,30 €
DT5042-QZ	2x4 mm	4,70 €
DT5046-QZ	5 mm	3,50 €
DT5048-QZ	6 mm	3,50 €
DT5052-QZ	8 mm	4,70 €

**PUNTE COBALTO EXTREME**

Per prestazioni eccezionali in foratura sull'acciaio INOX e materiali non ferrosi. Resistenza garantita fino a 1100 N/mm<sup>2</sup>. Adatto su lamiere dove è richiesta precisione e su tubi senza alcun problema.

CODICE	$\varnothing$	€ s/IVA
DT4902-QZ	2x3 mm	4,70 €
DT4904-QZ	2x4 mm	4,70 €
DT4906-QZ	5 mm	5,80 €
DT4908-QZ	6 mm	5,80 €
DT4912-QZ	8 mm	8,20 €

**PUNTE A GRADINO CON RIVESTIMENTO IN TITANIO**

**PUNTA AUTOCENTRANTE PER USO SU INOX-METALLI-PLASTICA**

CODICE	$\varnothing$	€ s/IVA
DT5030-QZ	7 diam.	60,00 €
DT5031-QZ	8 diam.	102,50 €
DT90246-QZ	10 diam.	65,40 €
DT90247-QZ	13 diam.	107,90 €
DT90248-QZ	8 diam.	57,80 €

**58<sup>90</sup> €**  
+ IVA

**UNA SOLA PASSATA PER FORARE, MASCHIARE, SVASARE**

**DT50060-QZ SET FORARE-MASCHIARE-SVASARE**

Set di qualità composto da 5 punte attacco esagonale 1/4". Misure: M4-M5-M6-M8-M10. Il set ideale per installatori, meccanici, elettricisti, automotive.

## SET ACCESSORI

**TOUGH CASE+** **EXTREME**

**39<sup>50</sup> €**  
+ IVA

**10 PEZZI**

**DT70753-QZ**  
**SET FORARE SDS-PLUS**

Cassetta 10 punte SDS+ Extreme2 diametri: 5-6x2 mm da 110mm, 6x2-7-8-9-10-12 mm da 160mm

**TOUGH CASE+** **XLR**

**57<sup>90</sup> €**  
+ IVA

**10 PEZZI**

**DT70752-QZ**  
**SET FORARE SDS-PLUS XLR**

Cassetta 10 punte SDS+ XLR diametri: 5-6x2 mm da 110mm, 6x2-6.5-8x2-10-12 mm da 160mm

**TOUGH CASE+** **EXTREME**

**39<sup>00</sup> €**  
+ IVA

**9 PEZZI**

**DT70751-QZ**  
**SET FORARE LEGNO**

Set 9 mechie Extreme attacco esagonale 1/4" misure: 12, 14, 16, 18, 20, 22, 25, 28, 32 mm

**DT70727-QZ** **18<sup>00</sup> €**  
+ IVA

**DT70728-QZ** **27<sup>80</sup> €**  
+ IVA

**DT70729-QZ** **36<sup>50</sup> €**  
+ IVA

**TOUGH CASE+**

**SET PUNTE ELICOIDALI PER FORARE METALLO-LEGNO-PLASTICA CON CODOLO TRIANGOLARE AD ALTA TENUTA**

**PUNTE CON NUOVA GEOMETRIA, NUCLEO RINFORZATO E FINITURA «NERO E DORATA»**

**DT70727-QZ** 14 punte - 1,1.5x2,2x2,2.5,3x2,3.5,4x2,5,6,8 mm  
**DT70728-QZ** 19 punte - 1,1.5,2x2,2.5x2,3x2,3.5x2,4x2,5x2,5.5,6,7,8,10 mm  
**DT70729-QZ** 23 punte - 1x2,1.5x2,2x2,2.5x2,3x2,3.5x2,4x2,4.5,5x2,6,7,8,9,10,12mm

# SET ACCESSORI

IN DOTAZIONE



**35<sup>.90</sup> €**  
+ IVA



**25 PEZZI**

## DT70707-QZ SET FORARE ED AVVITARE + TAZZA TERMICA

Cassetta con 25 pezzi: 15 inserti da 25mm: PH2 PZ2,3 T10,15,20,25,30 inserti da 50mm: PH2 PZ2,3 T25, 1 chiave a bussola 10mm, 1 guida magnetica, 4 punte metallo attacco 1/4" 3,4,5,6mm, 1 tazza termica



**34<sup>.90</sup> €**  
+ IVA



**25 PEZZI**

## DT70730T-QZ SET AVVITARE

Cassetta con 25 pezzi: 15 inserti da 25mm: PZ2,3 - SL6 - T20,25,30, 5 inserti da 57mm: PH2 - PZ2,3, 3 inserti da 85mm: PH2-PZ2-T20, 1 bussola magnetica 8mm, 1 adattatore magnetico con guida Torsion



**39<sup>.00</sup> €**  
+ IVA



**37 PEZZI**

## DT70731T-QZ SET AVVITARE

Cassetta con 37 pezzi: 22 inserti da 25mm: PH1,2,3 - PZ1,2,3 - T20,25,30 - SL 4, 11 inserti da 57mm: PH2 - PZ1,2,3 - T20,25, 2 inserti da 85mm: T20,25, 1 bussola magnetica in alluminio 10X, 1 adattatore magnetico con guida Torsion



**39<sup>.00</sup> €**  
+ IVA



**32 PEZZI**

## DT70743T-QZ SET AVVITARE

Cassetta con 32 pezzi: 22 inserti da 25mm: PH2 -PZ1,2,3 - SL6 - T15,20,25,30, 5 inserti da 57mm: PH2 - PZ2,3 - T20,30, 3 inserti da 85mm: PH2-PZ2-T25, 1 bussola magnetica 8mm, 1 adattatore magnetico con guida Torsion



**32 PEZZI**

## DT71516-QZ SET CRICCHETTO

Cassetta con 24 pezzi: 15 Inserti misti da 25mm, 6 Bussole, 1 Adattatore, 1 Porta inserti magnetico, 1 Cricchetto

**26<sup>.50</sup> €**  
+ IVA



**6<sup>.90</sup> €**  
+ IVA



**10 PEZZI**

## DT7276-QZ SET AVVITARE

Set 10 inserti da 57mm Pozidriv: 2 PZ1 - 6 PZ2 - 2 PZ3

## DT7275-QZ SET AVVITARE

Set 10 inserti da 57mm Torx: 3 T20 - 4 T25 - 3 T30

**16<sup>.90</sup> €**  
+ IVA



**32 PEZZI**

## DT7969-QZ SET AVVITARE

Cassetta con 32 pezzi: 30 inserti misti da 25mm, 1 adattatore, 1 porta inserti magnetico

**36<sup>.00</sup> €**  
+ IVA



**100 PEZZI**

## DT71566-QZ SET FORARE ED AVVITARE

Cassetta 100 pezzi: 12 punte metallo, 7 punte muratura, 5 punte legno, 1 adatt. magnetico, 53 inserti misti da 25mm, 15 inserti misti da 50mm, 2 seghe a tazza, 1 mandrino per sega a tazza, 3 inserti a bussola, 1 punta a svasare



**24<sup>.50</sup> €**  
+ IVA



**40 PEZZI**

## DT70702-QZ SET AVVITARE

Cassetta 40 pezzi: 14 inserti da 50mm: PH1,2-PZ2,3-T15,20,25,30 21 inserti da 25mm: PH1,2,3-PZ2,3-T15,20,25,30 2 inserti da 85mm: PH2, PZ2 2 bussole esagonali 8,10 mm, 1 adattatore magnetico con guida



**Sei un utilizzatore finale e vuoi contattarci?**

Vai sul nostro sito:

<https://support.dewalt.com/hc/it-it/requests>



Oppure chiamaci: tel. 02.8295.3653 da Lunedì a Venerdì dalle 08:30 alle 19:30.

DEWALT® Stanley Black & Decker Italia S.r.l.  
Via Energy Park 6 - 20871 Vimercate (MB)  
Numero verde: 800.014353  
Mail: [dewalt.italia@dewalt.com](mailto:dewalt.italia@dewalt.com)



**MI PIACE  
DEWALT**

Scopri le nostre  
ultime novità,  
promozioni e molto  
altro su:



Distribuito Da:

[www.DEWALT.com](http://www.DEWALT.com)

Lo schema di colori giallo e nero è usato su DEWALT utensili elettrici e accessori come un marchio di fabbrica. DEWALT si riserva il diritto di modificare qualsiasi accordo in qualsiasi momento senza preavviso. Offerte disponibili fino ad esaurimento scorte.

Vuoi restare aggiornato sulle novità di DEWALT?  
Registrati su MyDEWALT: [www.DEWALT.com/MyDEWALT](http://www.DEWALT.com/MyDEWALT)



**REGISTRATI A**

**MY DEWALT**